

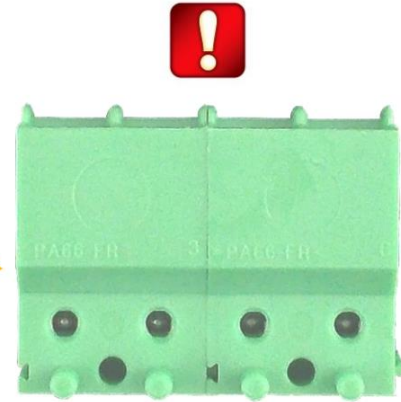

# Zapojení hlásičů a modulů řady FI700

1.4.2020

# FI700/MCP

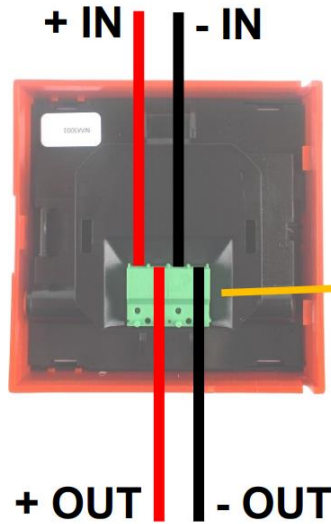
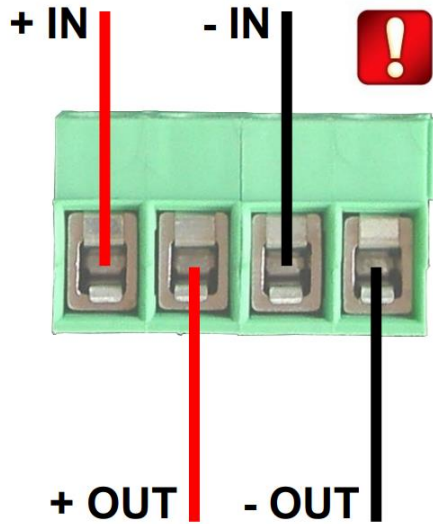

Pic. 4

# FI750/B



Figure 3

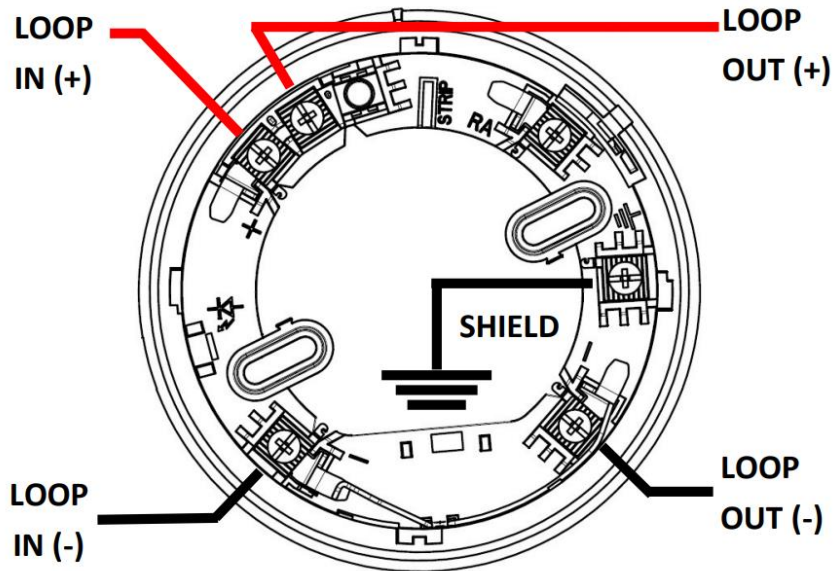
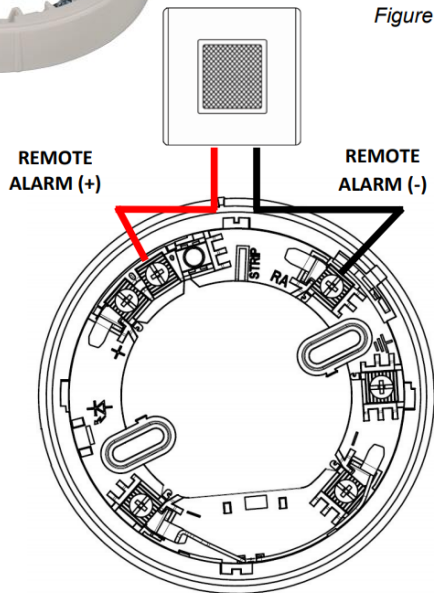

# FI750/WBRI/MT/SOUW



- Zapojení při použití s detektorem

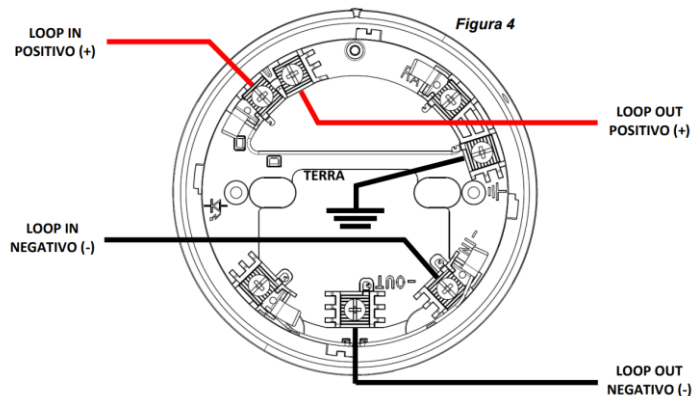

- Zapojení při použití bez detektoru

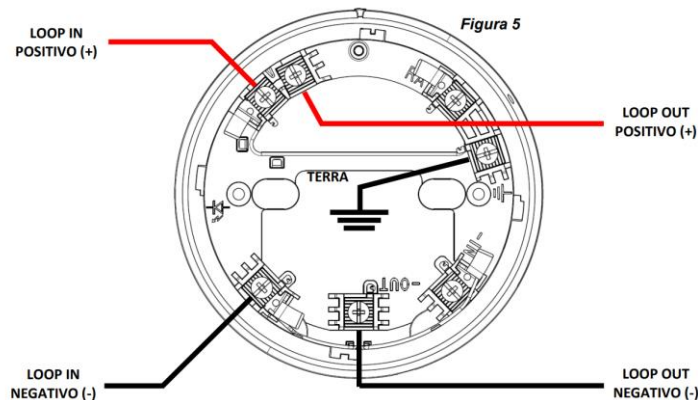

# FI700/M1IN1OUT



Reol - zakončovací rezistor 27 K $\Omega$   
Rw - poplachový rezistor 10 K $\Omega$

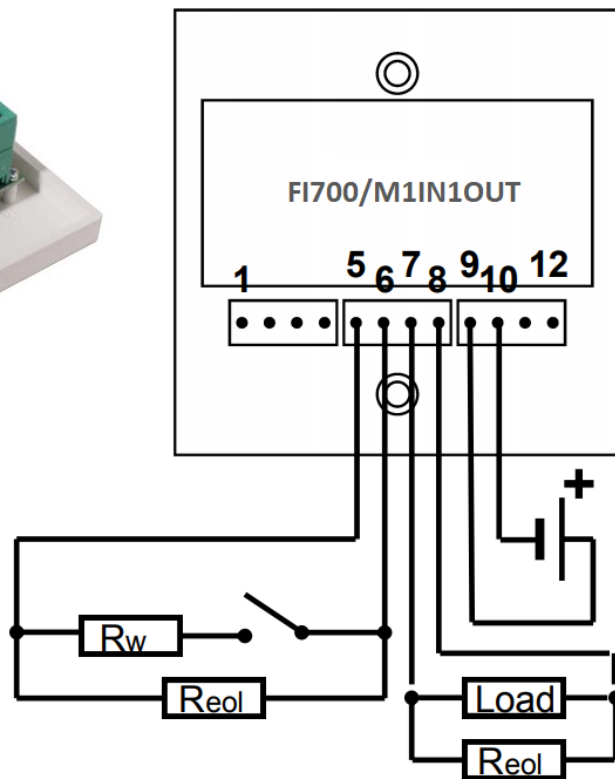

Svorky	
1	Linka IN (+)
2	Linka OUT (+)
3	Linka IN (-)
4	Linka OUT (-)
5	Vstup (+)
6	Vstup (-)
7	Výstup (+)
8	Výstup (-)
9	Externí napájení 24V (+)
10	Externí napájení (-)
11	Nepoužito
12	Nepoužito

# FI700/M1IN1REL

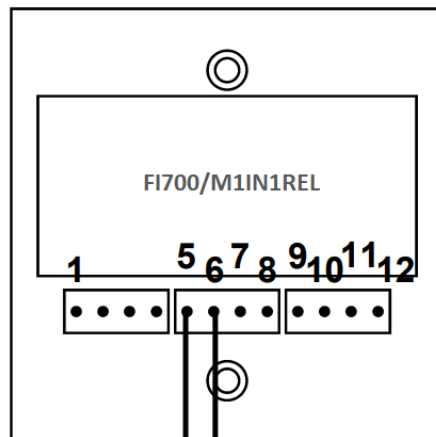

Reol - zakončovací rezistor 27 K $\Omega$   
Rw - poplachový rezistor 10 K $\Omega$

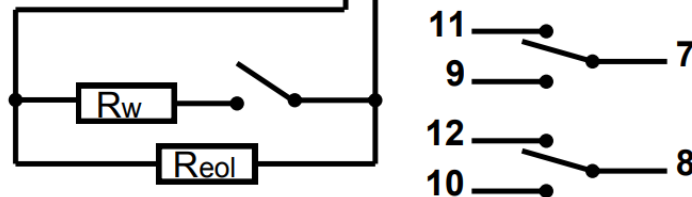

Svorky	
1	Linka IN (+)
2	Linka OUT (+)
3	Linka IN (-)
4	Linka OUT (-)
5	Vstup (+)
6	Vstup (-)
7	Kontakt relé C 1
8	Kontakt relé C 2
9	Kontakt relé NO 1
10	Kontakt relé NO 2
11	Kontakt relé NC 1
12	Kontakt relé NC 2

# FI700/M4IN4REL

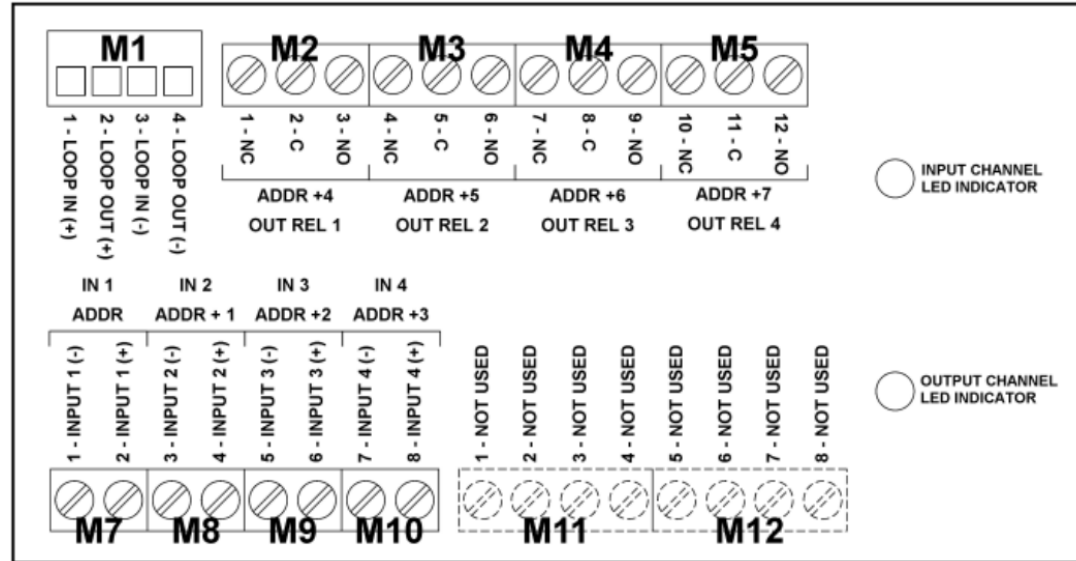

# FI700M4IN2OUT2REL

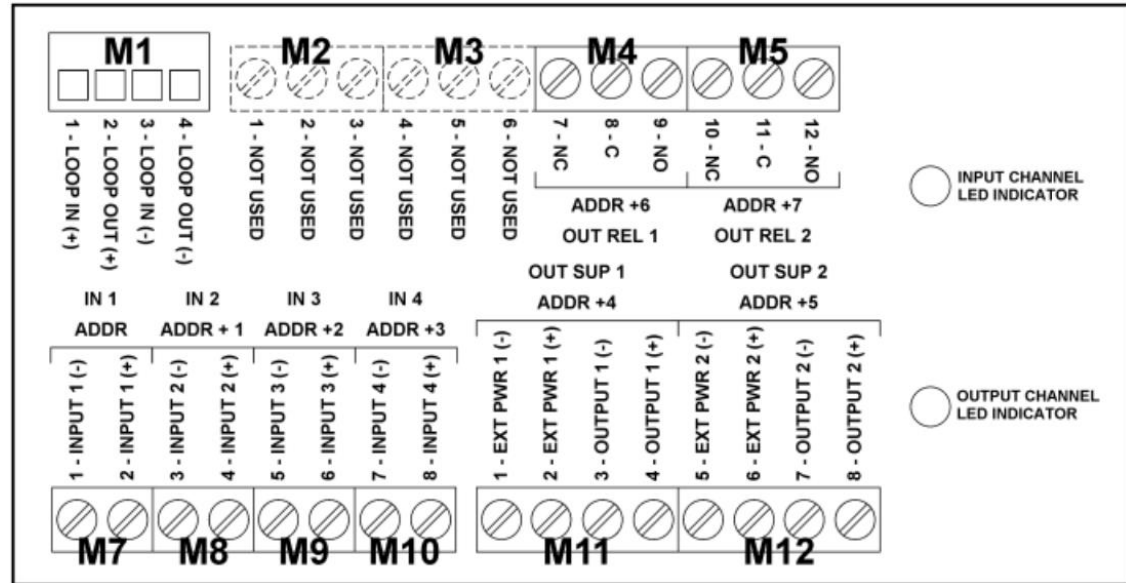



# FI700M6IN2REL

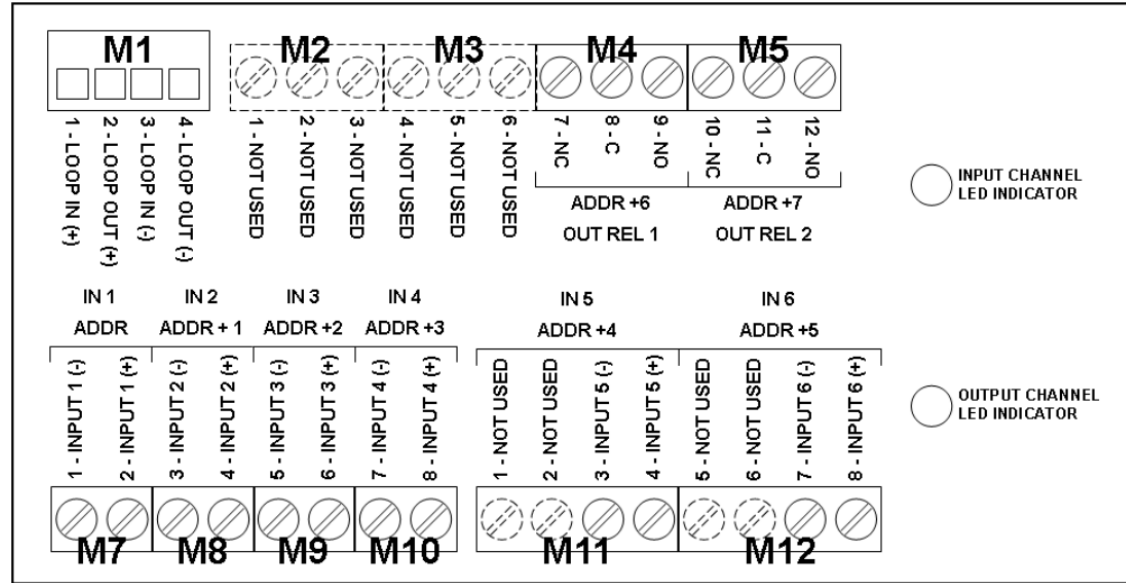

# FI720/RF/W2W

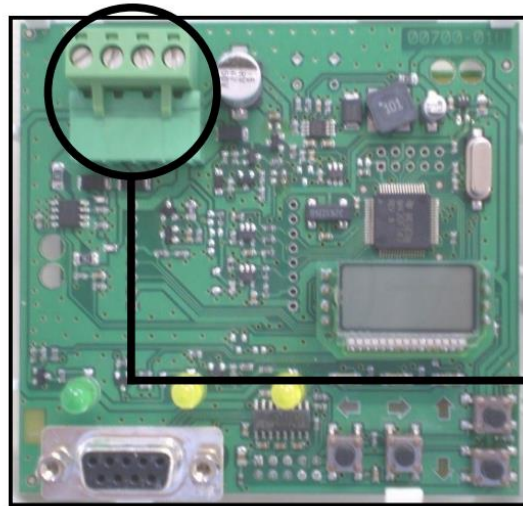
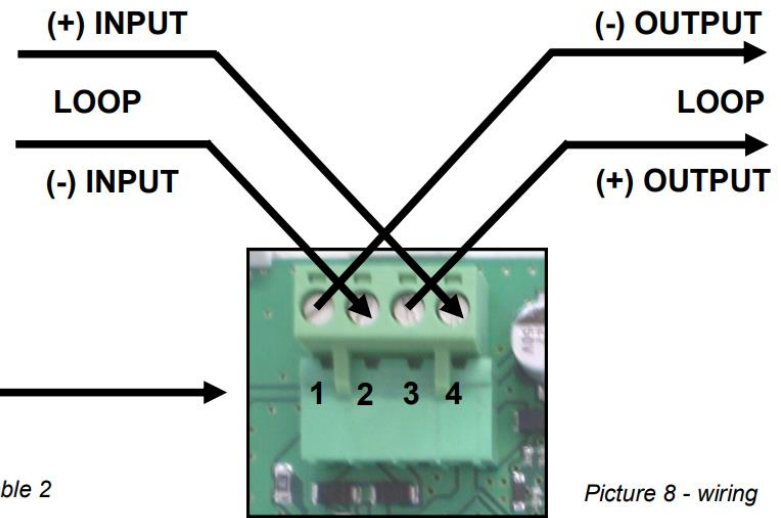
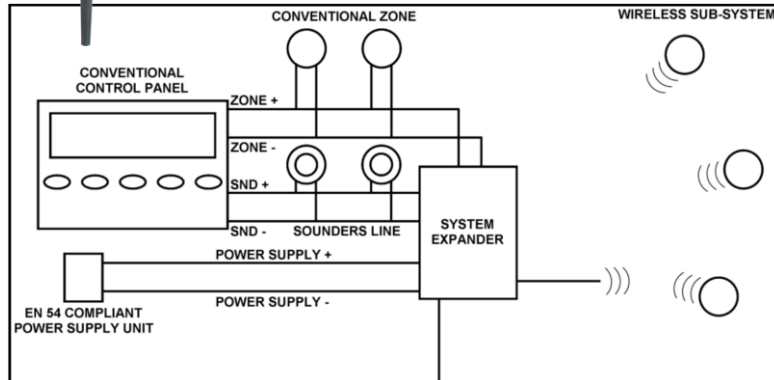
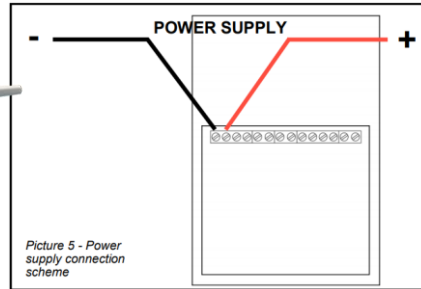

Table 2



# FI720/RF/CWE

## ■ Zapojení zálohovaného zdroje EN 54



### **WARNING!**

**“POWER SUPPLY -” AND “POWER SUPPLY +” WIRES MUST PASS INTO THE SUPPLIED FERRITE RING.**

# FI720/RF/CWE

## ■ Zapojení konvenční smyčky

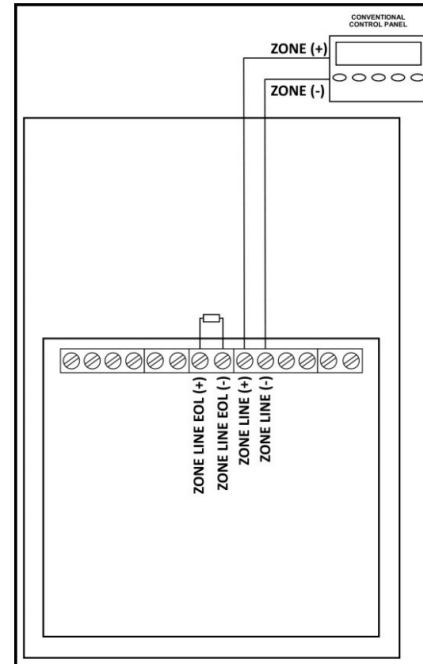
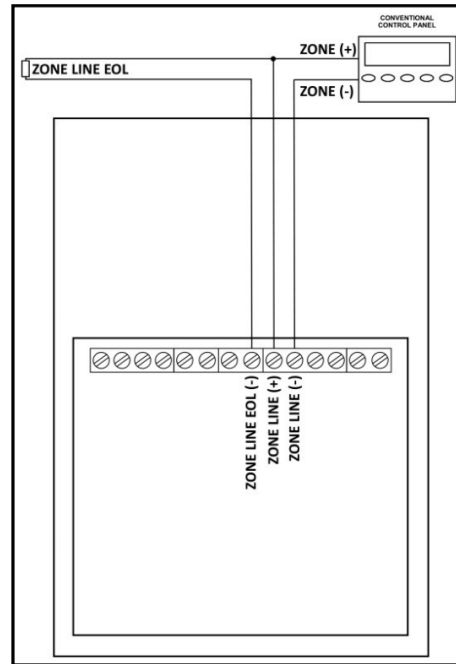

# FI720/RF/CWE



## ■ Zpojení sirénového výstupu

