

Příloha Seznam schémat zapojení

MDS 1A.....	48
MDS 1B.....	49
MDS 1C.....	50
MDS 2A.....	51
MDS 2B.....	52
MDS 2C.....	53
MDS 3A.....	54
MDS 3B.....	55
MDS 3C.....	56
MDS 4A.....	57
MDS 4B.....	58
MDS 4C.....	59
MDS 5A.....	60
MDS 5B.....	61
MDS 5C.....	62
MDS 6A.....	63
MDS 6B.....	64
MDS 6C.....	65
MDS 7A.....	66
MDS 7B.....	67
MDS 8A.....	68
MDS 9C.....	69
MDS 10C	70
MDS 11C.....	71
MDS 12A	72
MDS 13A	73
MDS 14A	74
MDS 15A	75
MDS 16A	76
MDS 17A	77
MDS 17B	78
MDS 17C	79
MDS 19A	80
MDS 19B	81
MDS 19C	82
MDS 21A	83
MDS 22A	84
MDS 23U	85
MDS 24U	86
MDS 25U	87
MDS 26U	88
MDS 27U	89
MDS 28U	90
MDS 29U	91
MDS 30U	92
MDS 34A	93
MDS 36U	94
MDS 37U	95
MDS 38U	96

<i>MDS 39U</i>	97
<i>MDS 40U</i>	98
<i>MDS 41U</i>	99
<i>MDS 42U</i>	100
<i>MDS 43U</i>	101
<i>MDS 49U</i>	102
<i>MDS 50U</i>	103
<i>MDS 52U</i>	104
<i>MDS 53U</i>	105
<i>MDS 54A</i>	106
<i>MDS 55A</i>	107
<i>MDS 56A</i>	108
<i>MDS 57A</i>	109
<i>MDS 58A</i>	110
<i>MDS 58B</i>	111
<i>MDS 58C</i>	112
<i>MDS 59A</i>	113
<i>MDS 59B</i>	114
<i>MDS 59C</i>	115
<i>MDS 64A</i>	116
<i>MDS 65A</i>	117
<i>MDS 66A</i>	118
<i>MDS 66B</i>	119
<i>MDS 66C</i>	120
<i>MDS 67A</i>	121
<i>MDS 67B</i>	122
<i>MDS 67C</i>	123
<i>MDS 68A</i>	124
<i>MDS 68B</i>	125
<i>MDS 68C</i>	126
<i>MDS 69A</i>	127
<i>MDS 69B</i>	128
<i>MDS 69C</i>	129
<i>MDS 70U</i>	130
<i>MDS 71U</i>	131
<i>MDS 74A</i>	132
<i>MDS 75A</i>	133
<i>MDS 76U</i>	134
<i>MDS 77U</i>	135
<i>MDS 80A</i>	136
<i>MDS 83A</i>	137
<i>MDS 84A</i>	138
<i>MDS 87U</i>	139
<i>MDS 90A</i>	140
<i>MDS 95A</i>	141
<i>MDS 95B</i>	142
<i>MDS 96A</i>	143
<i>MDS 97A</i>	144

<i>MDS 98U</i>	145
<i>MDS 99A</i>	146
<i>MDS 103U</i>	147
<i>MDS 116U</i>	148
<i>MDS 117U</i>	149
<i>MDS 118U</i>	150

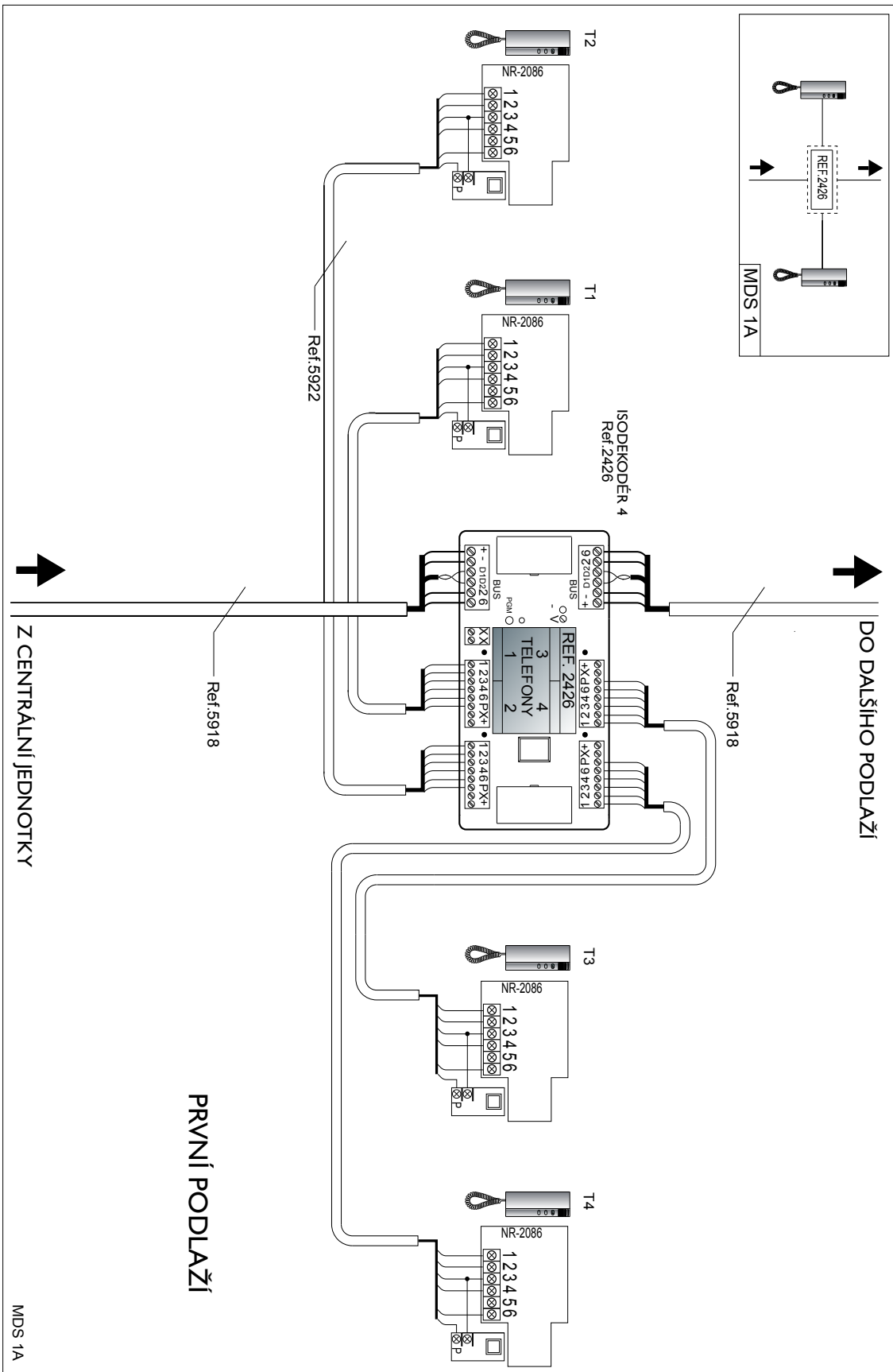

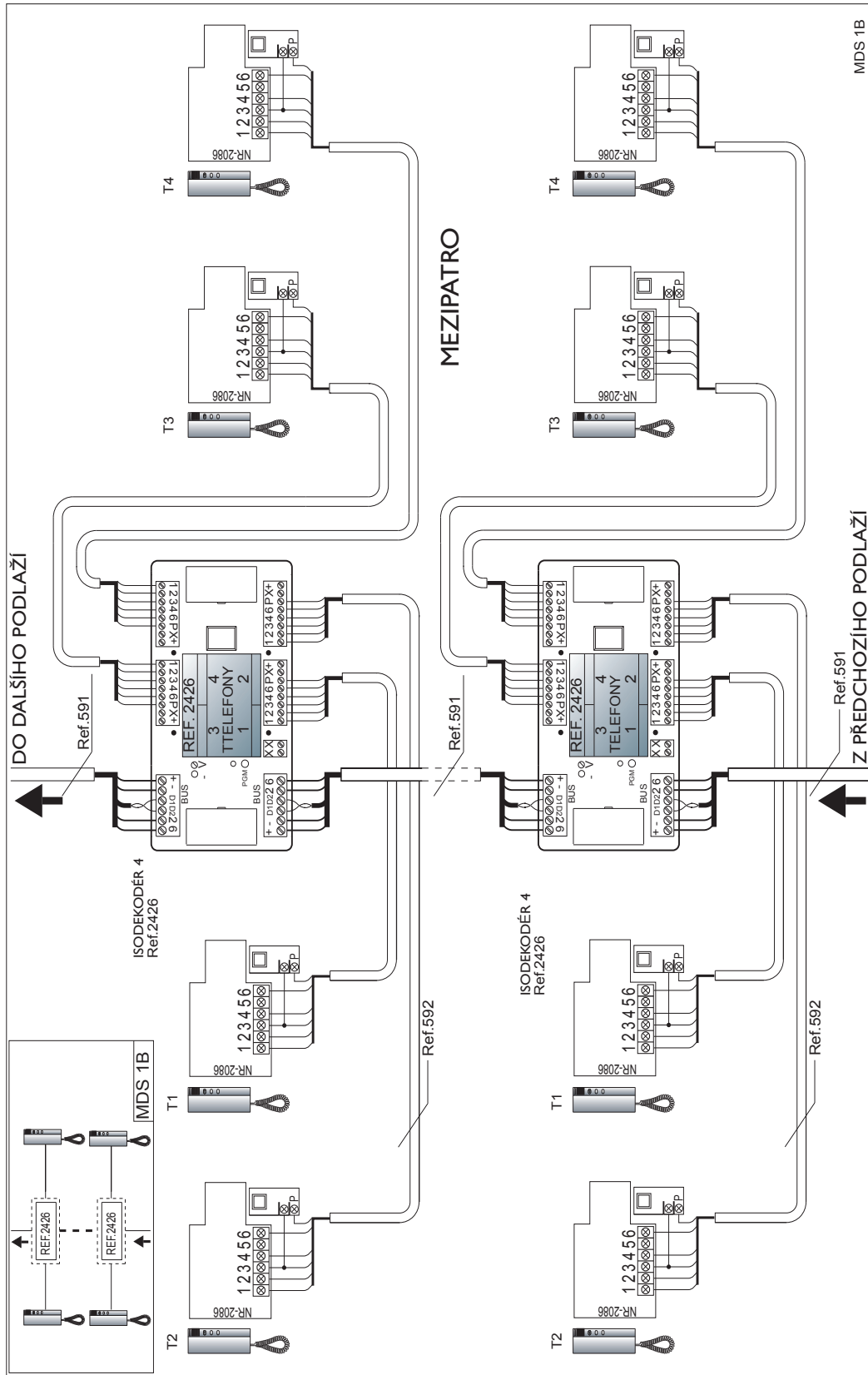

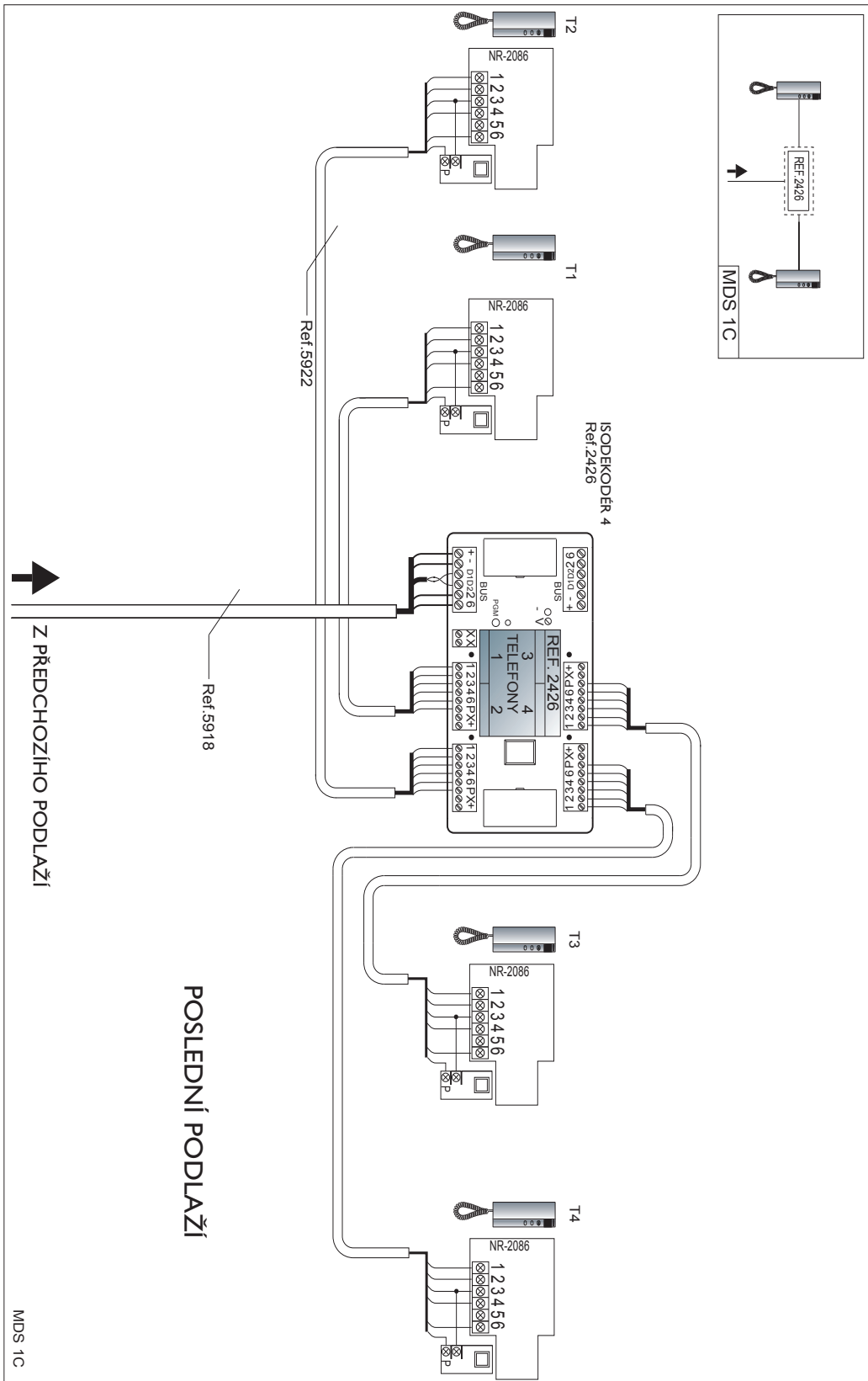

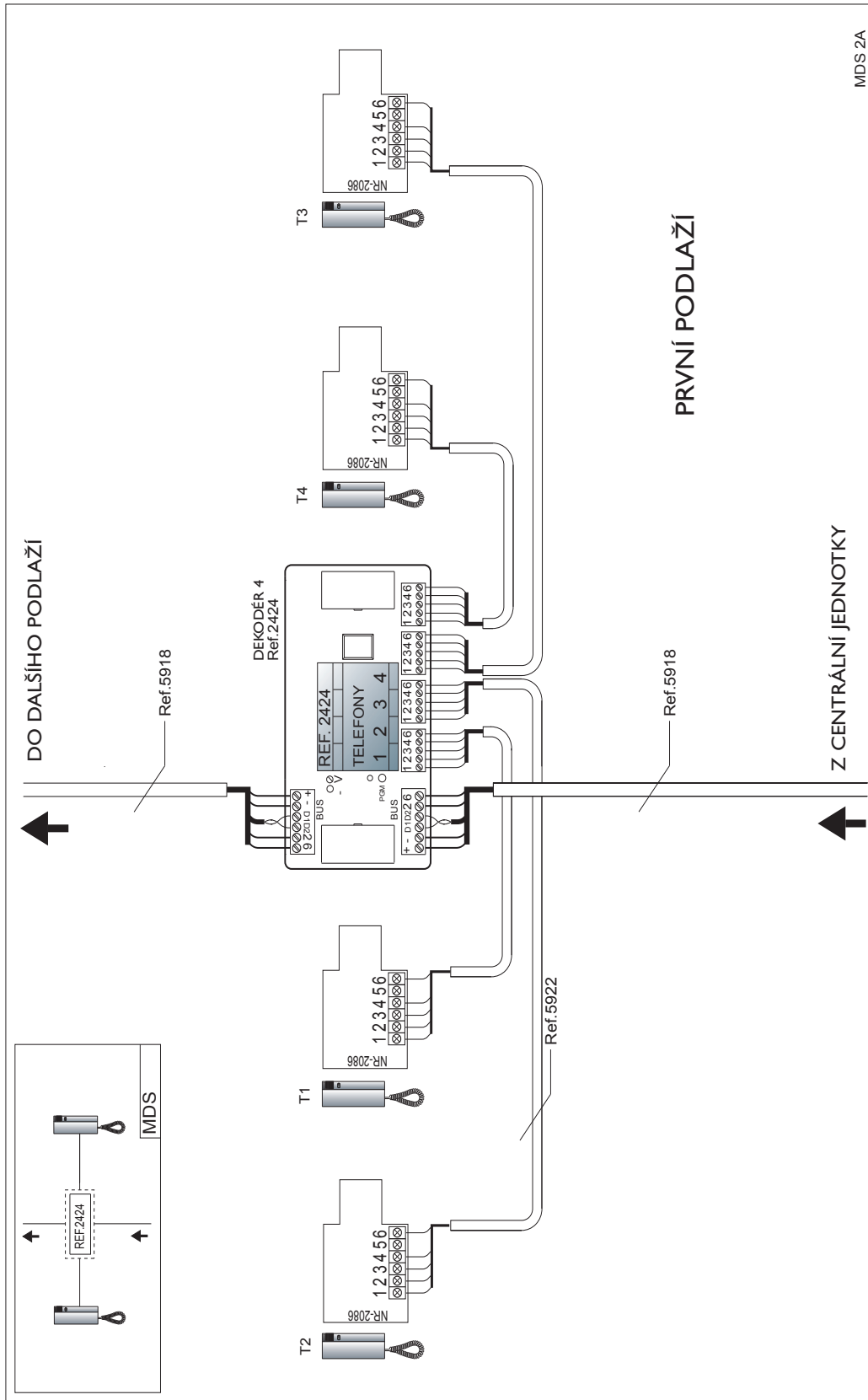

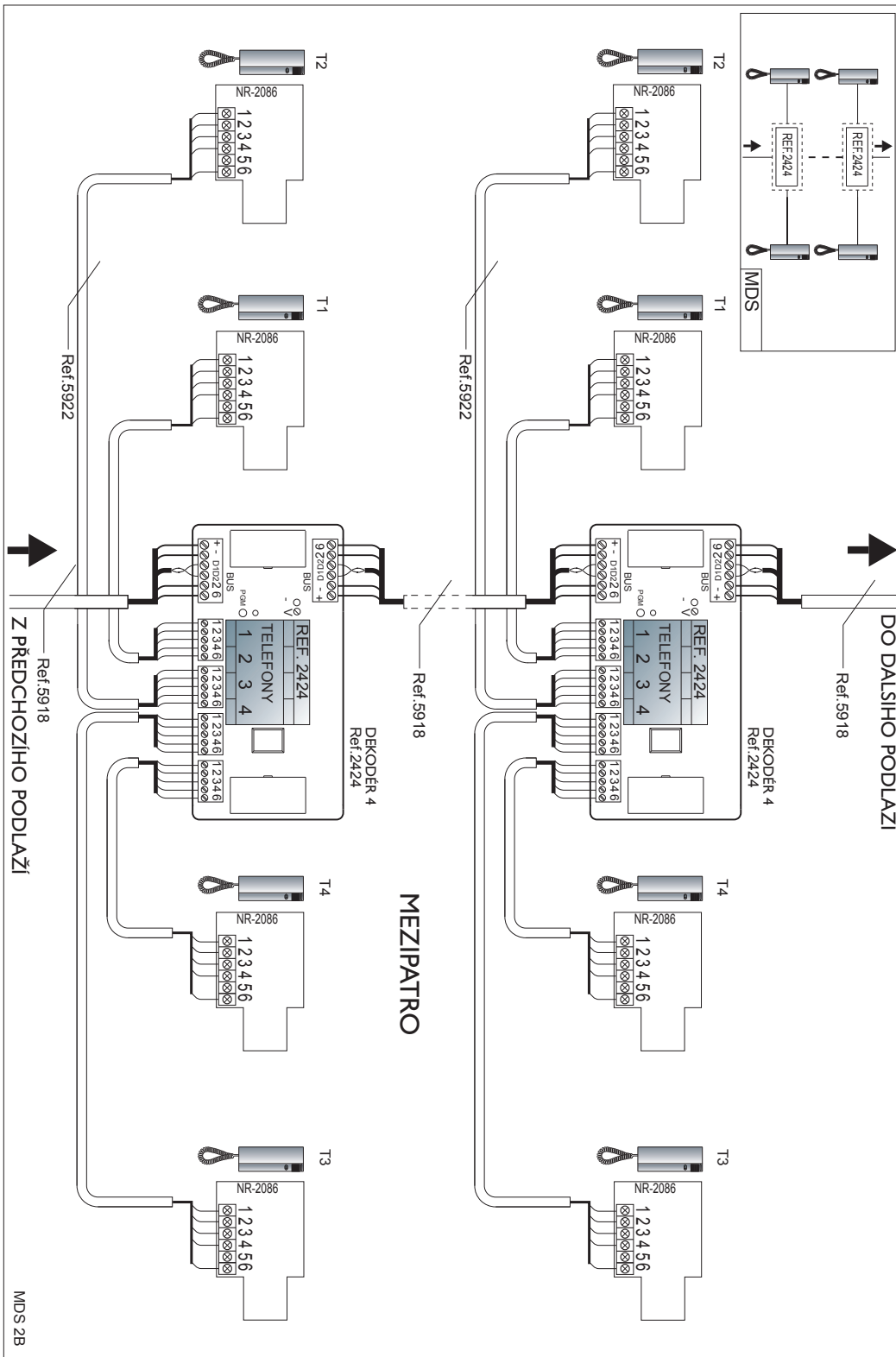

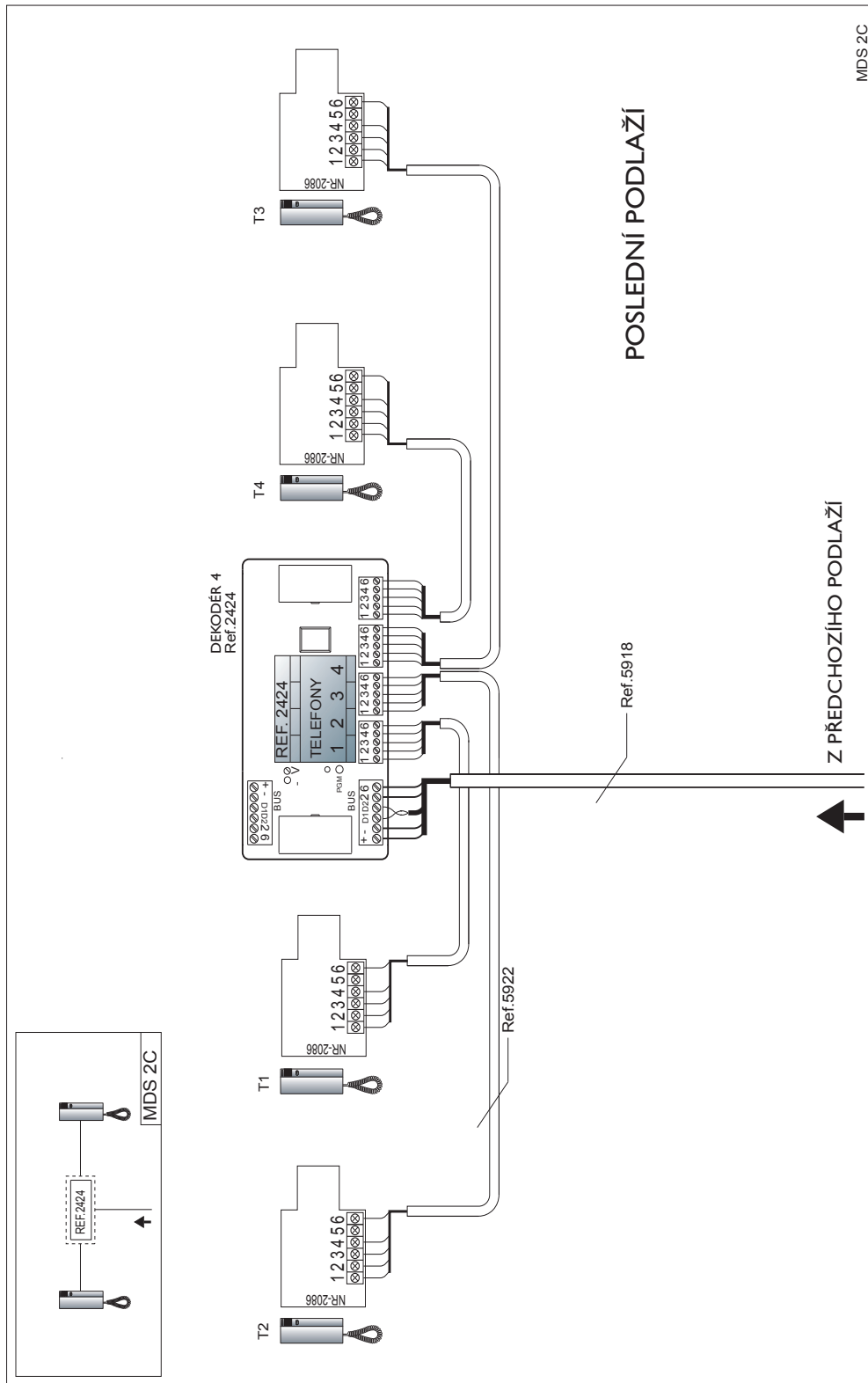

MDS 2C

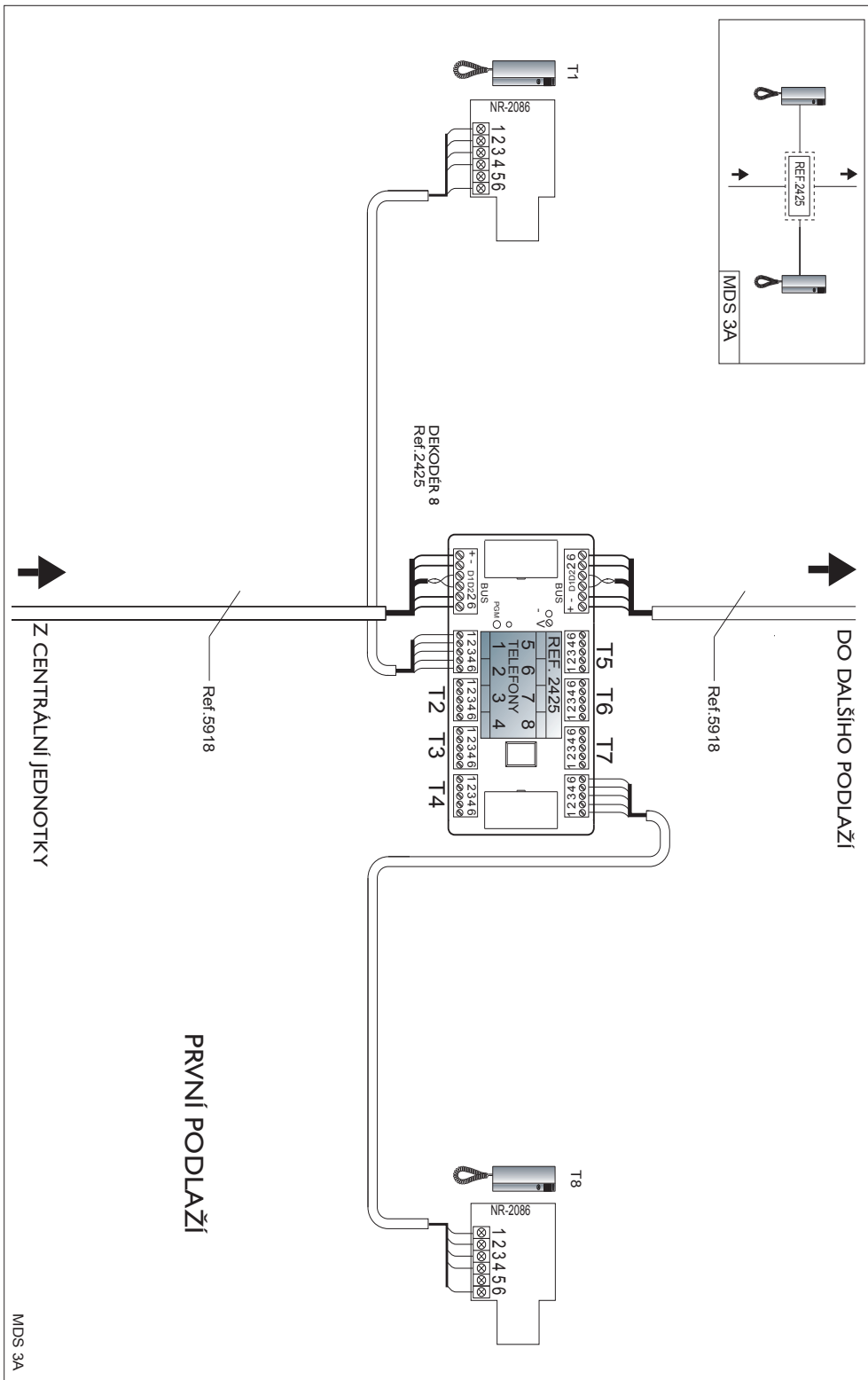

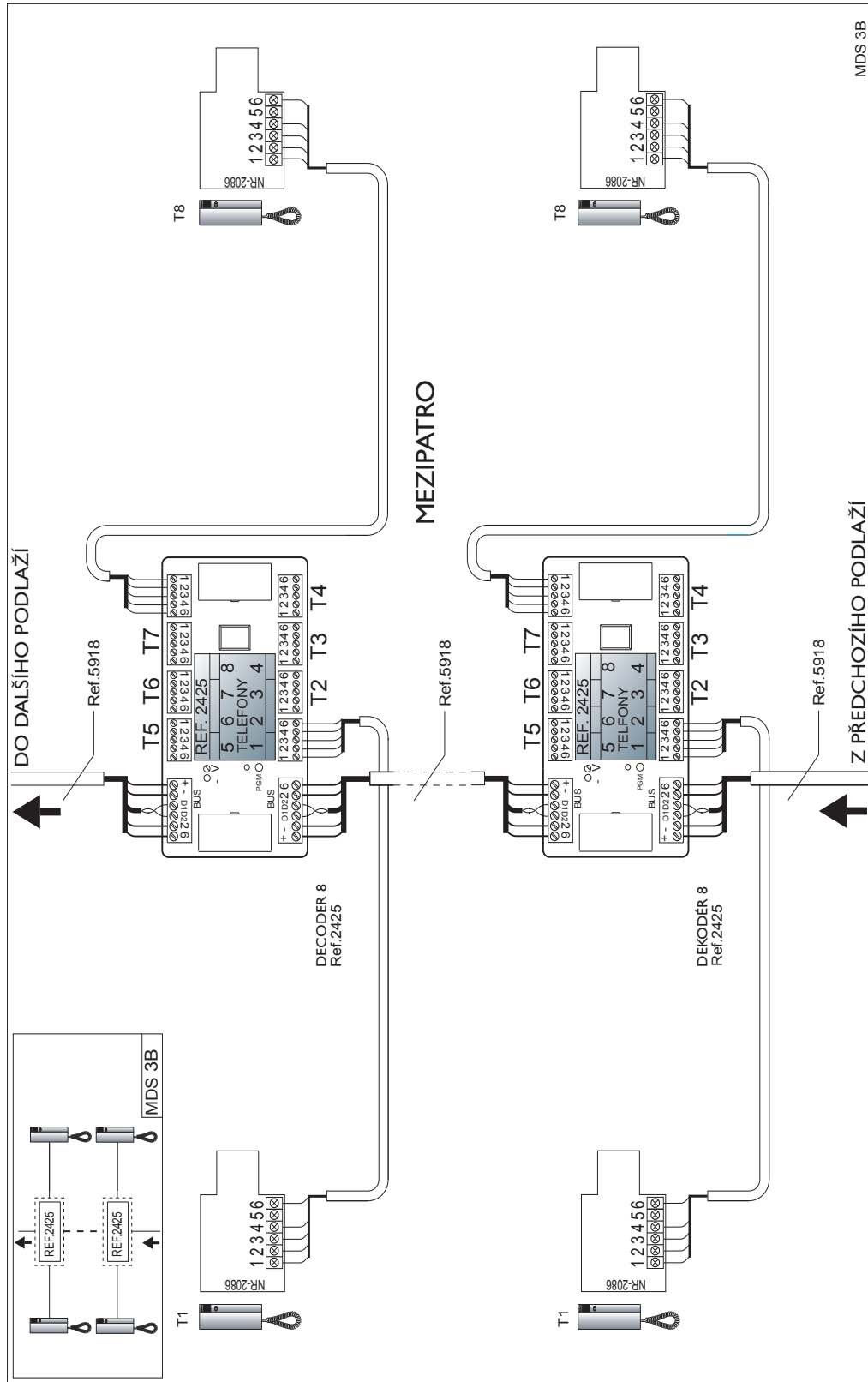

MDS 3B

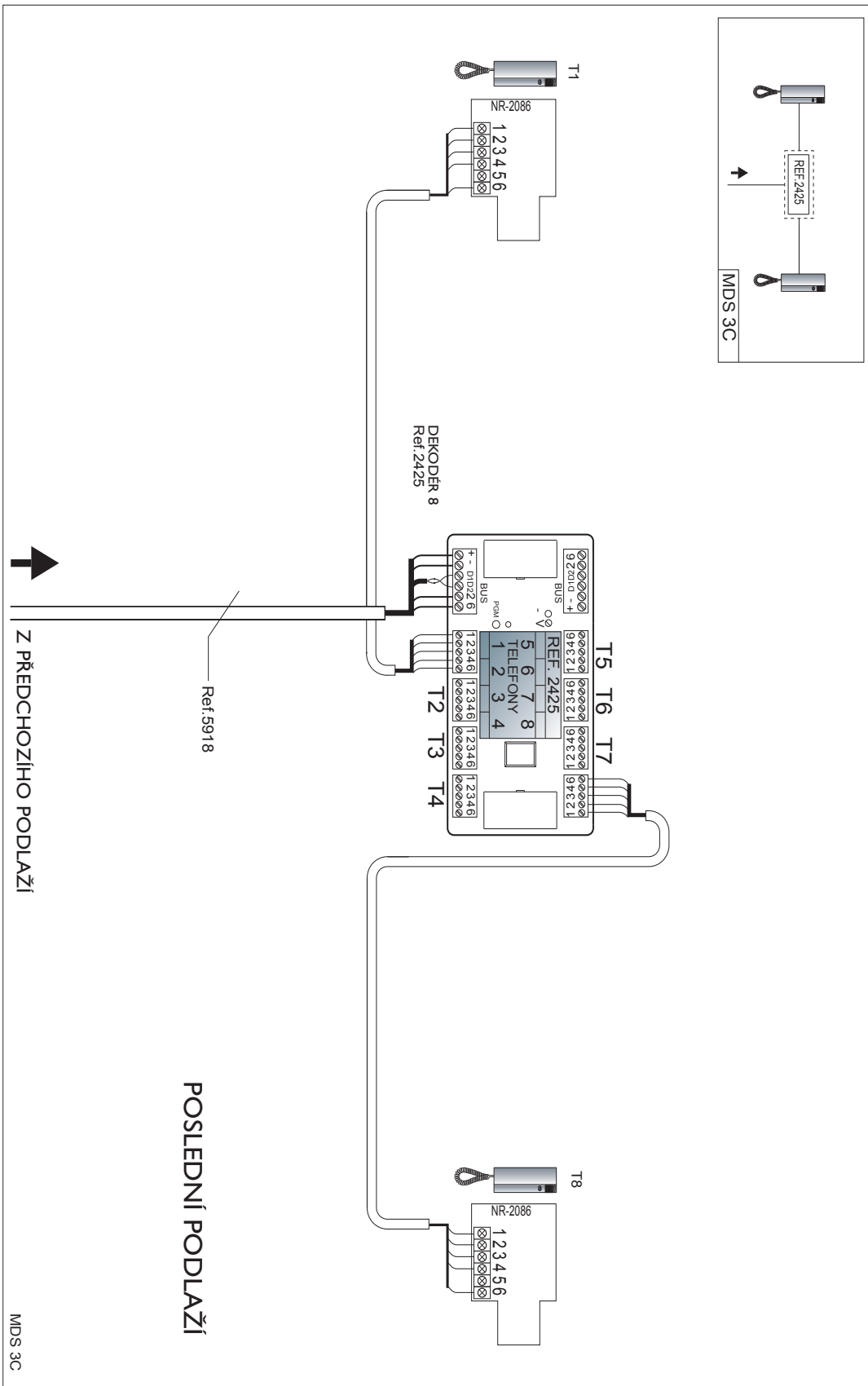

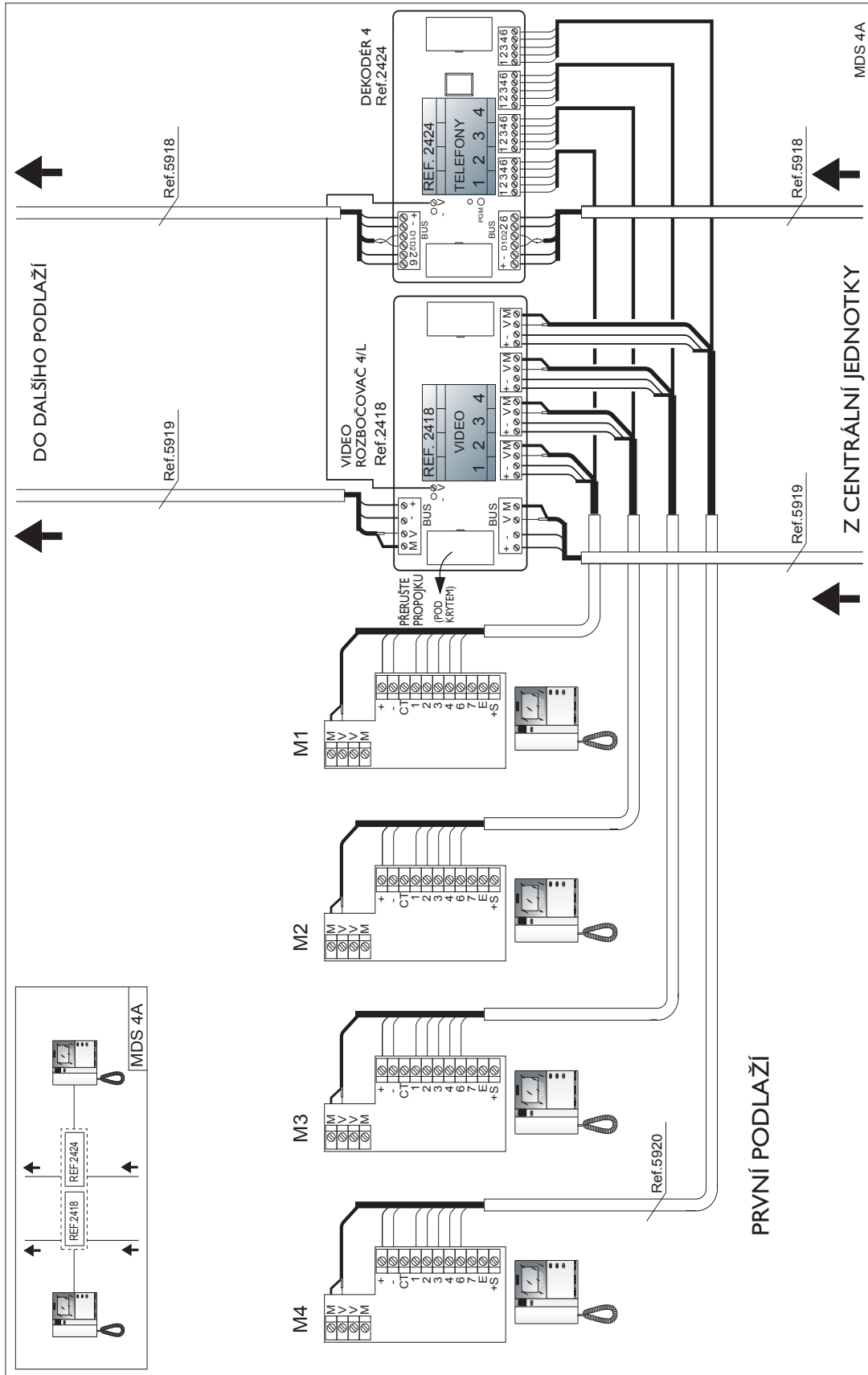

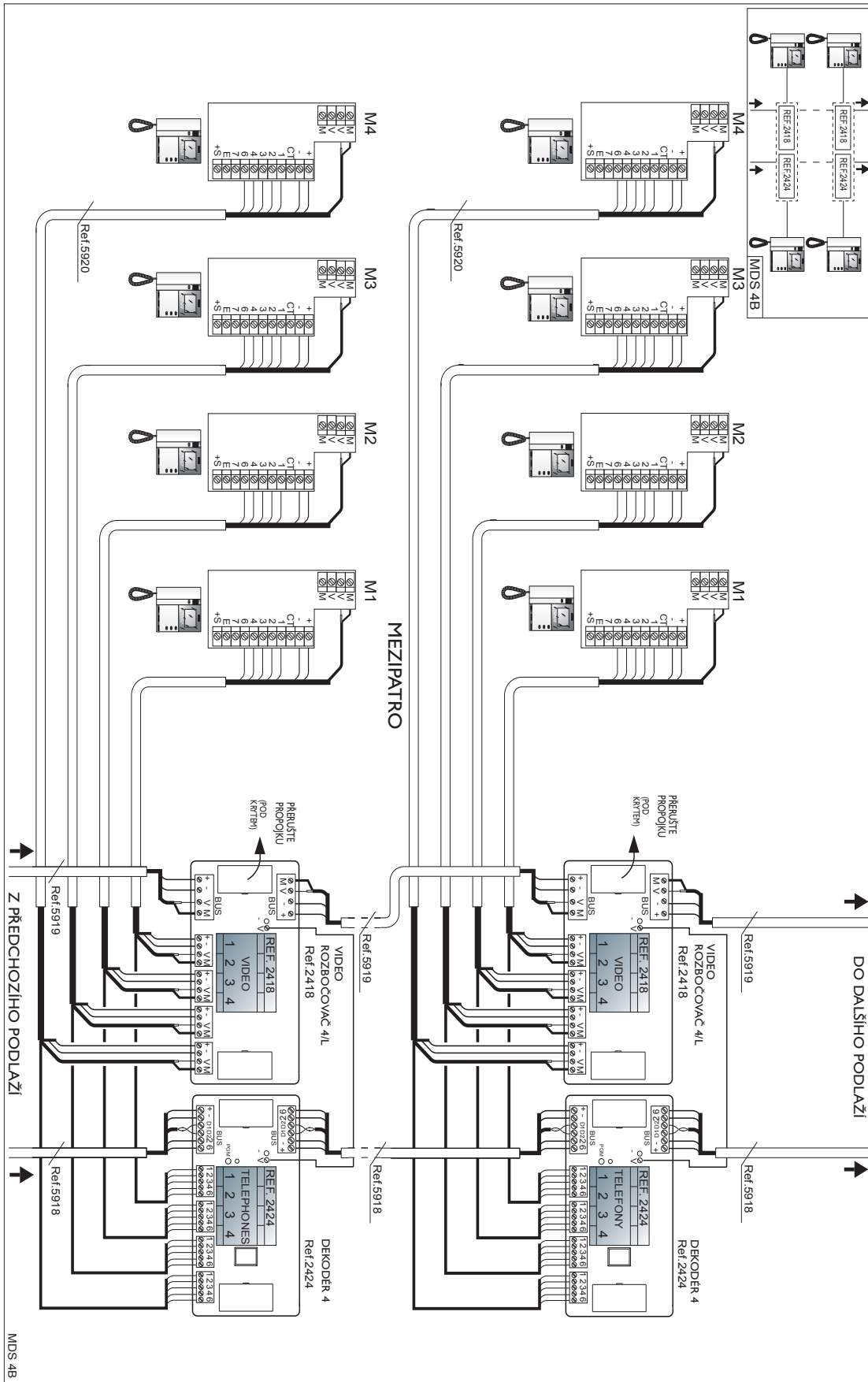

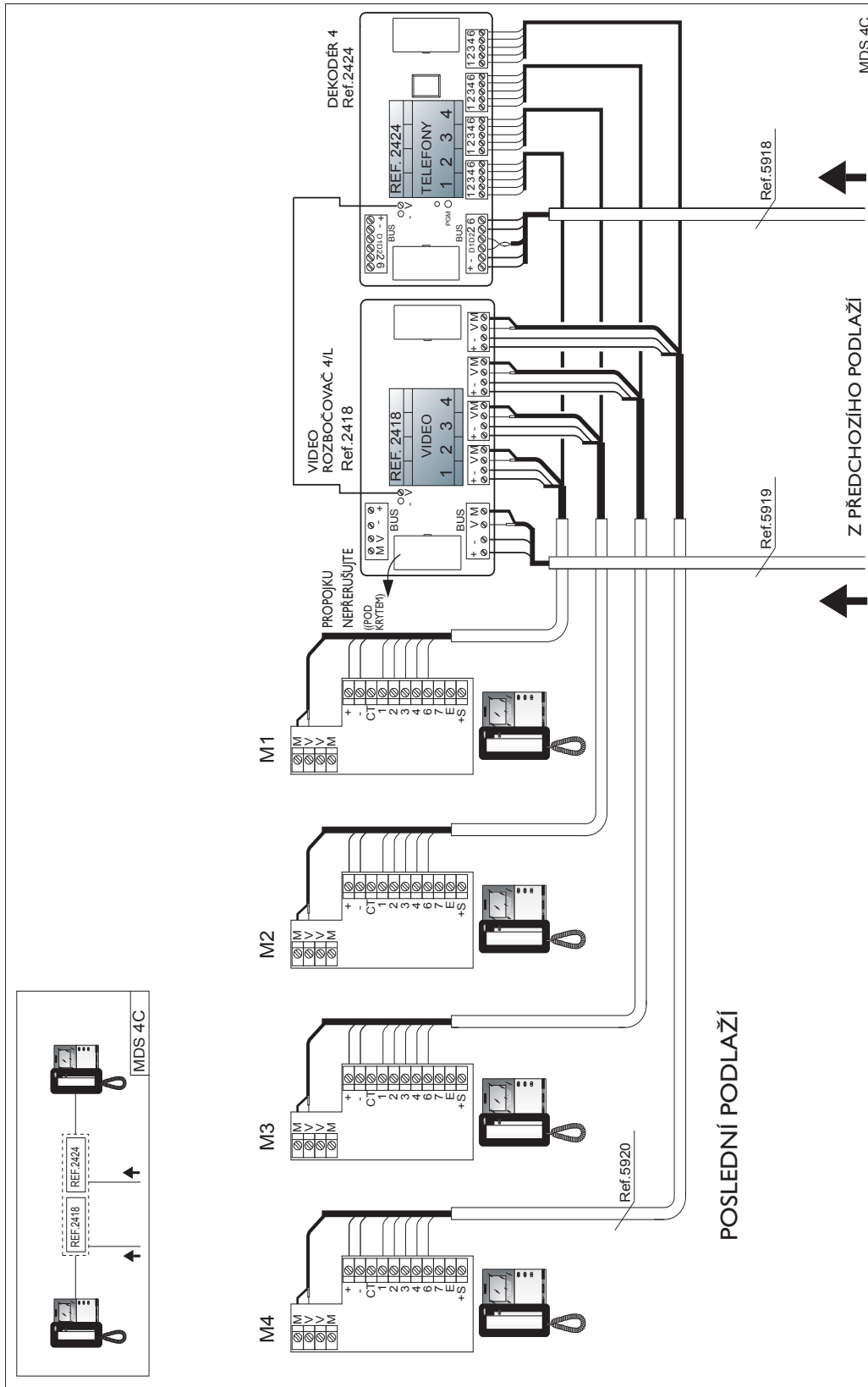

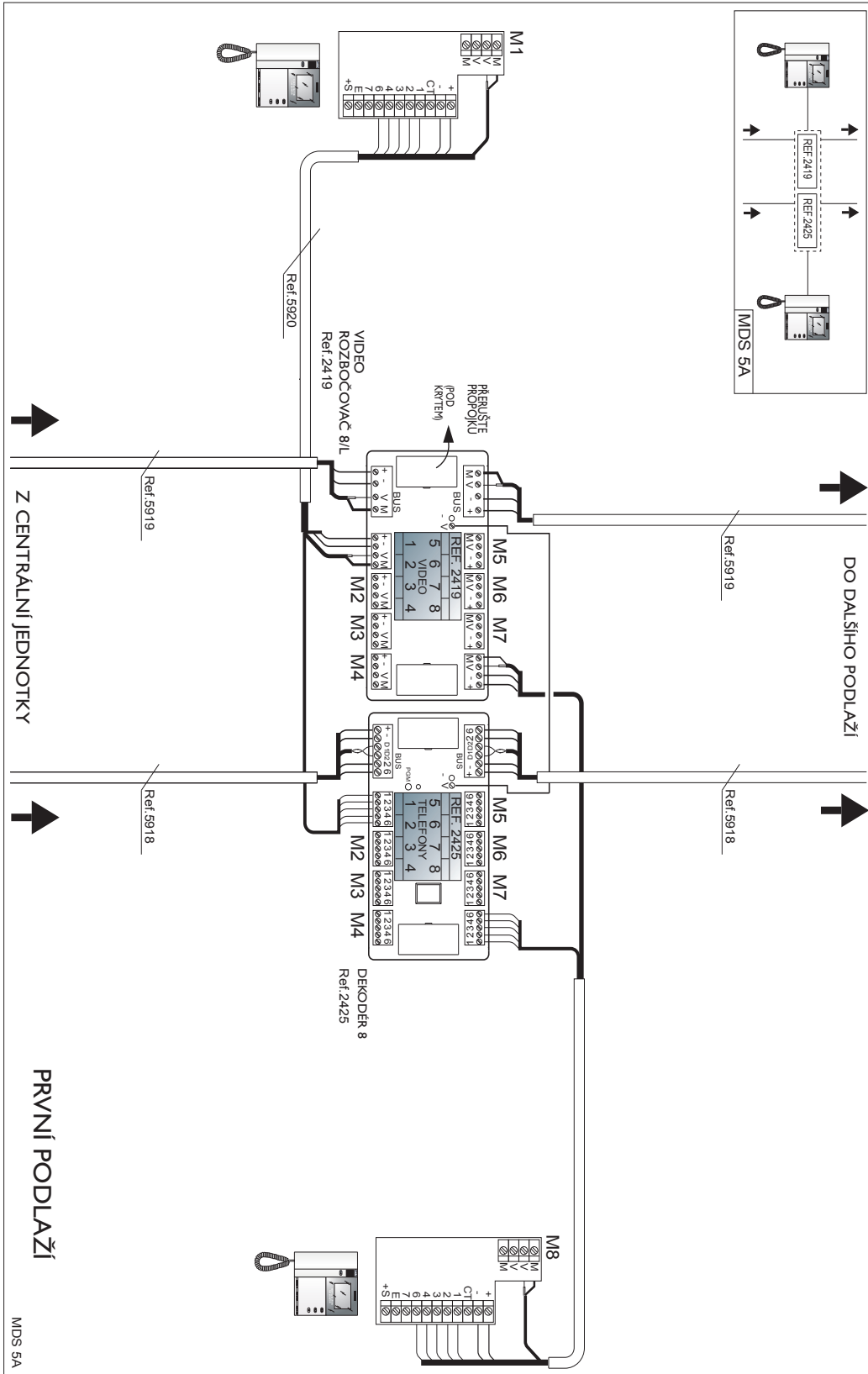

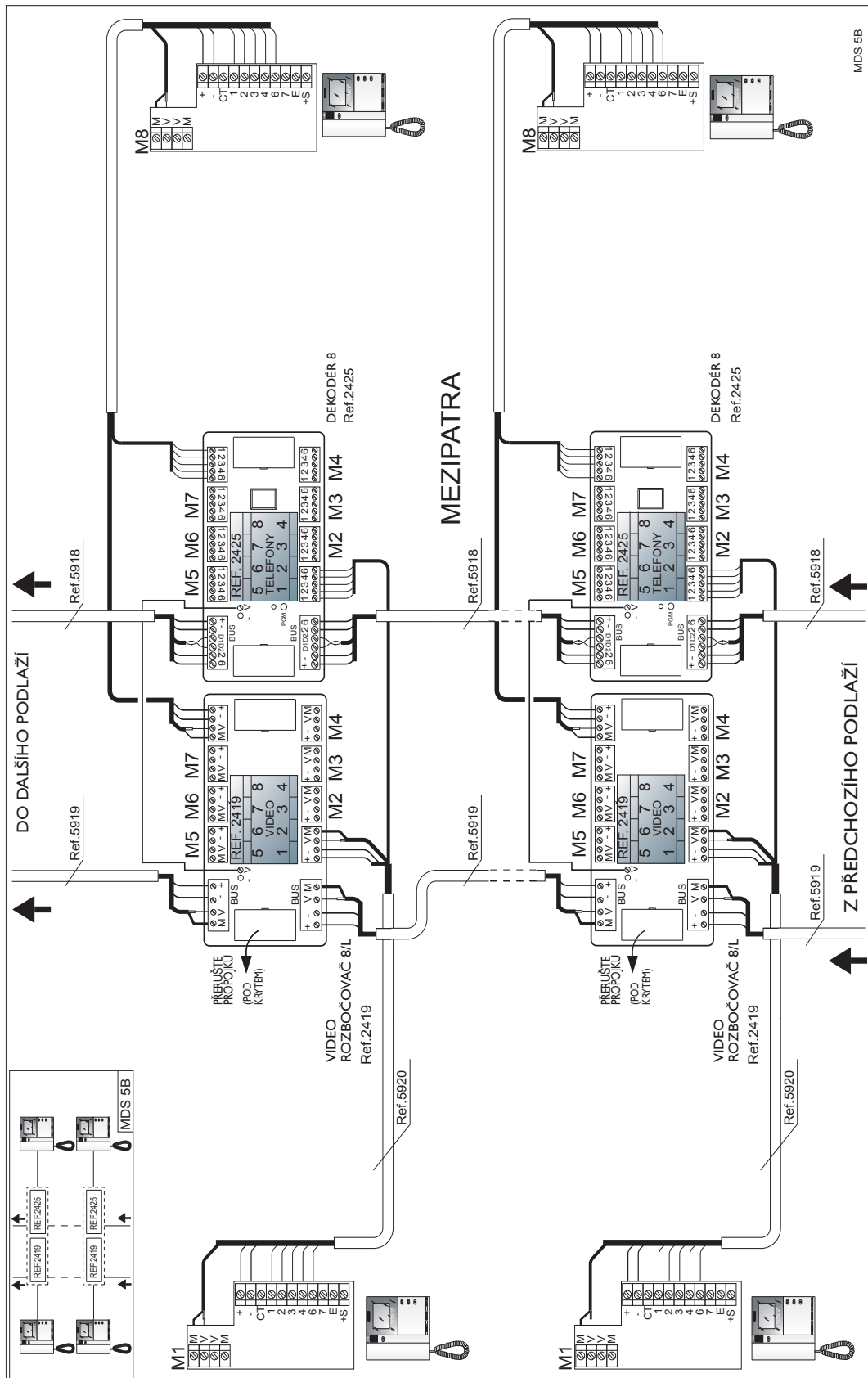

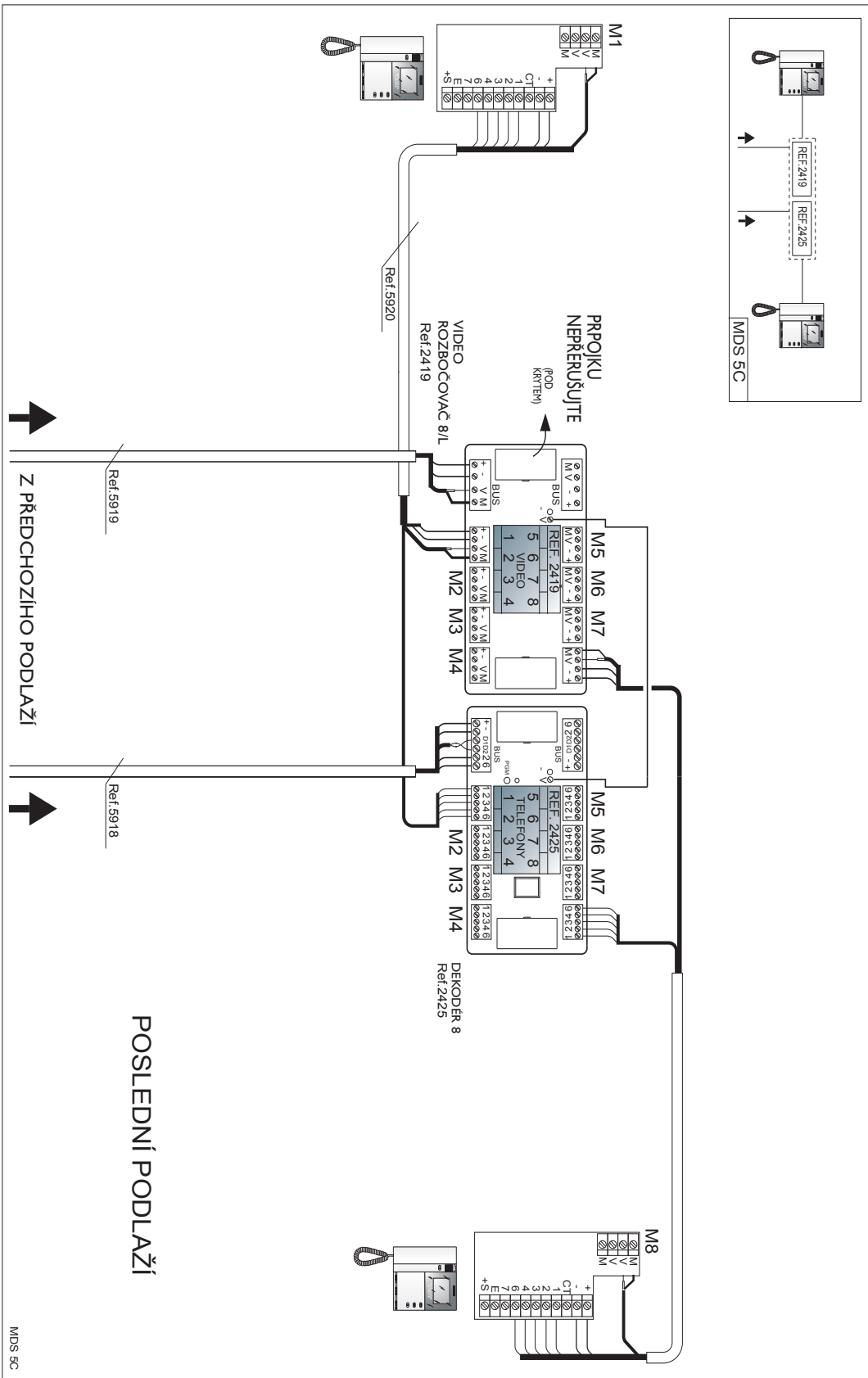

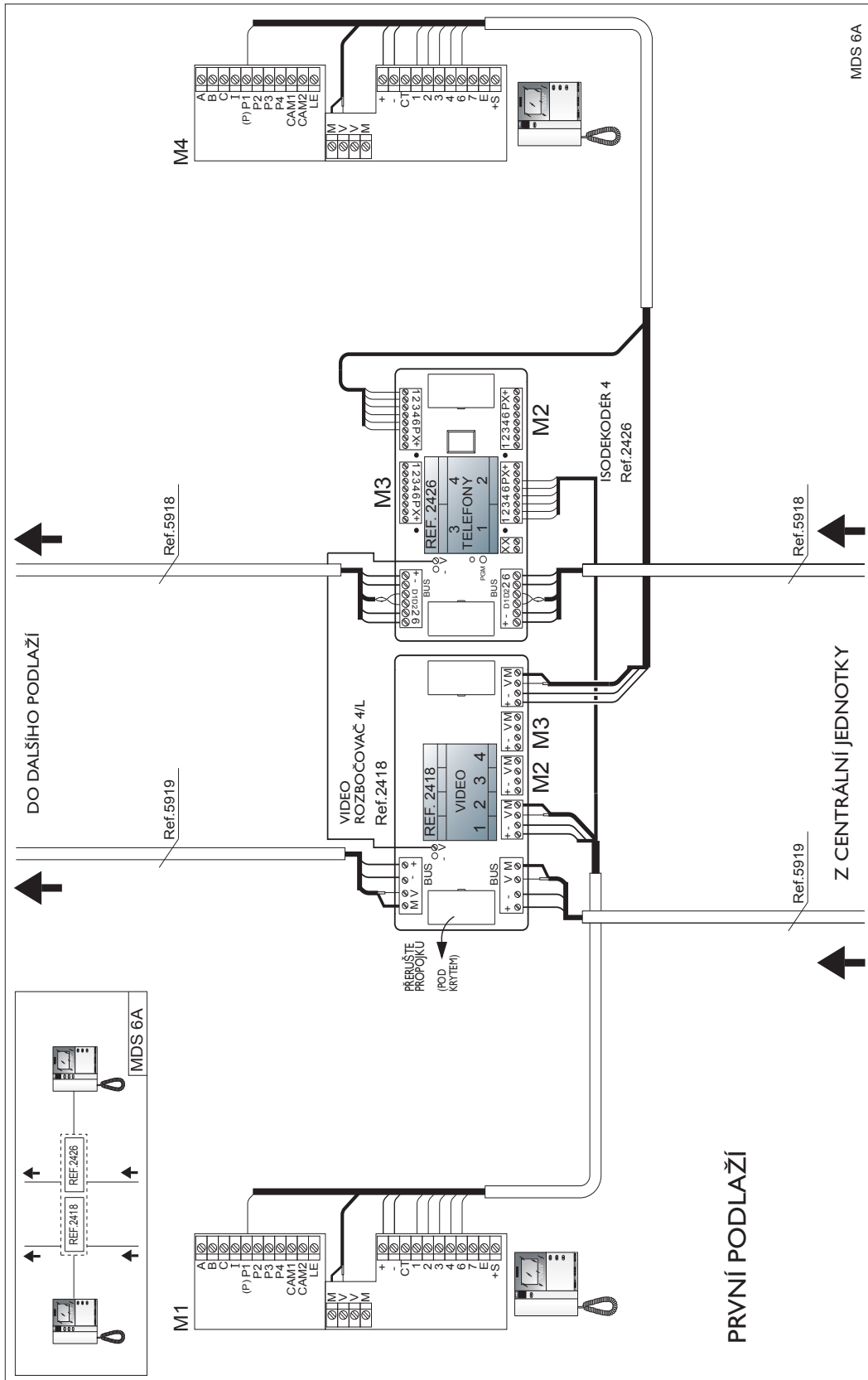

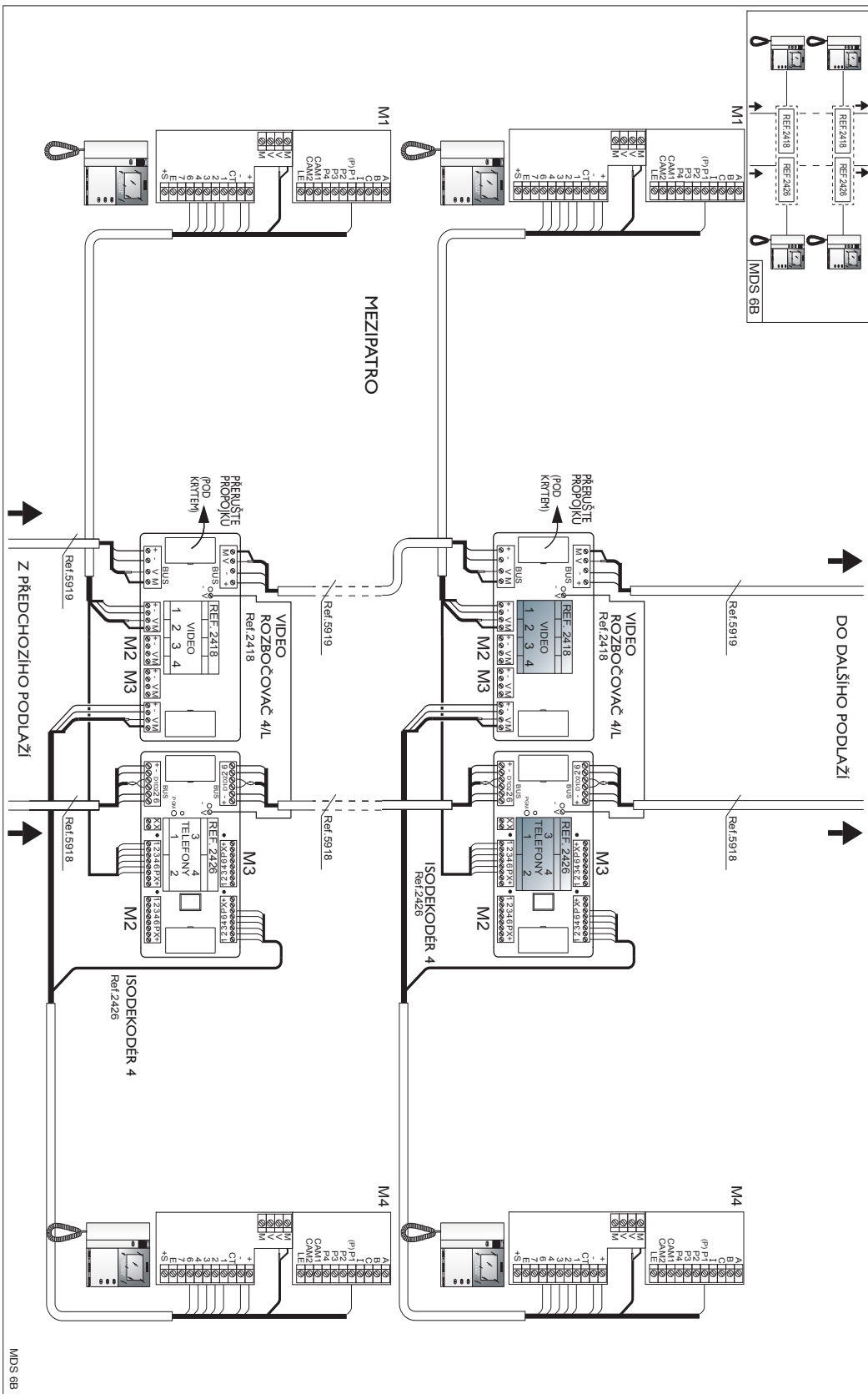

MDS 6B

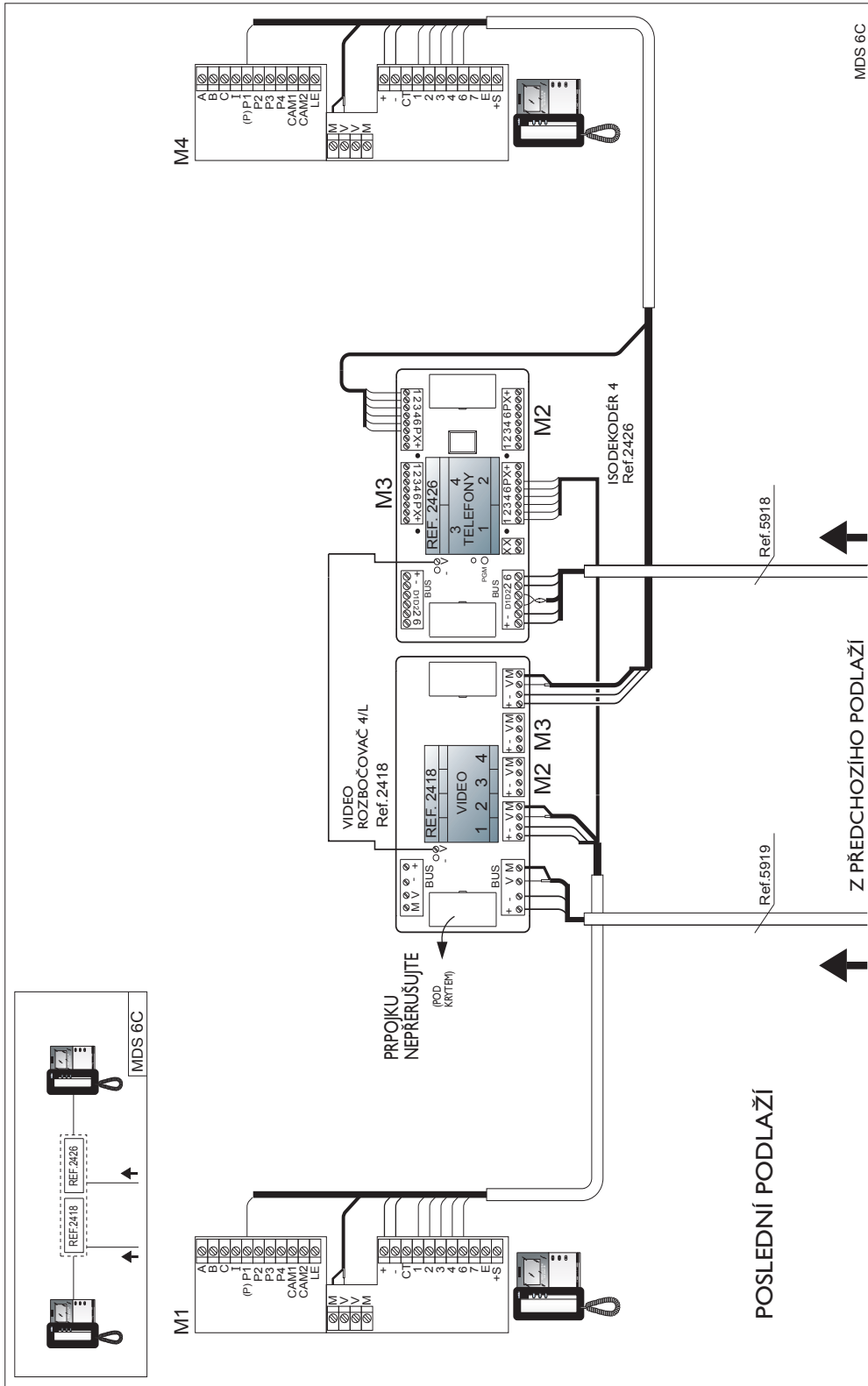

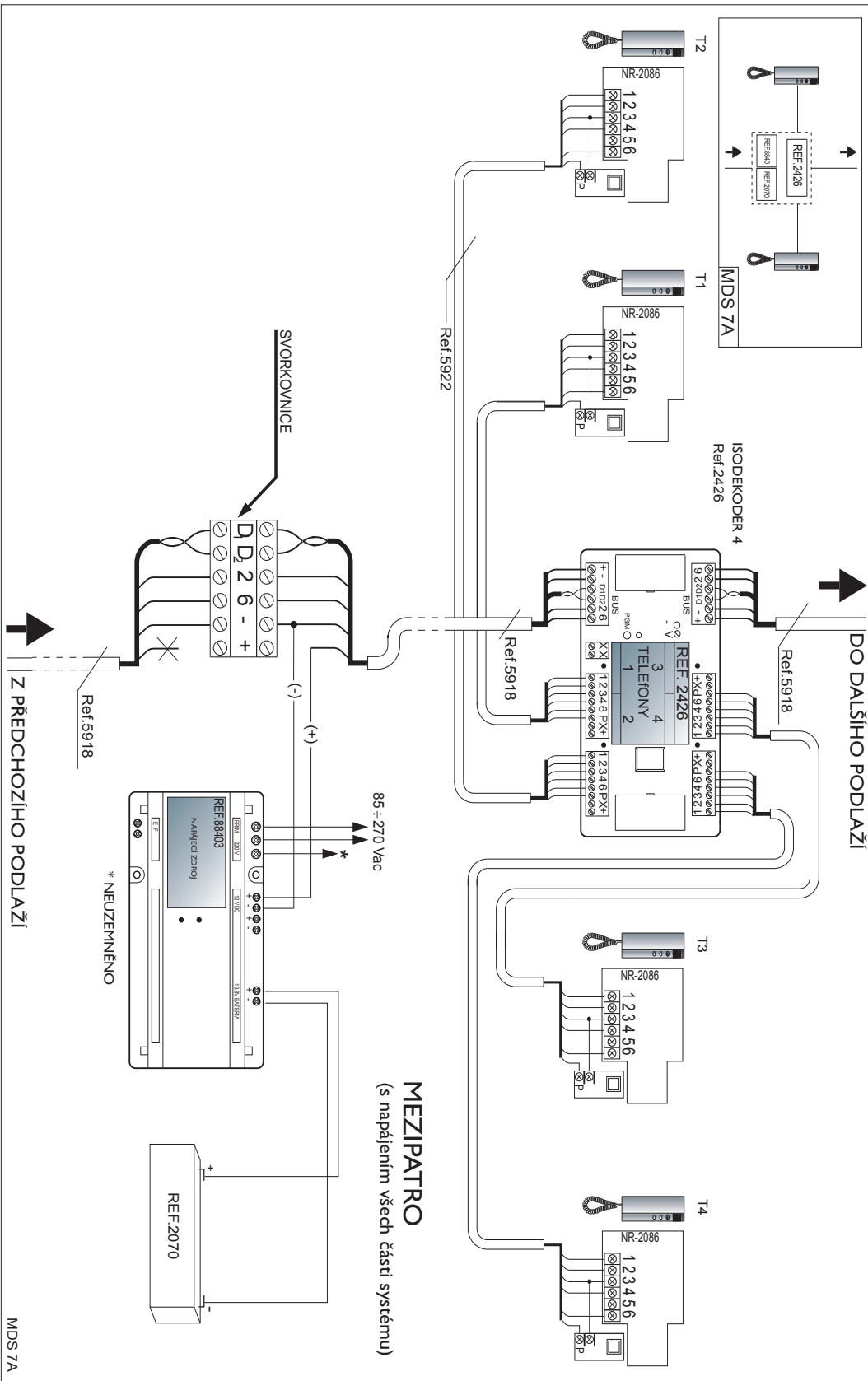

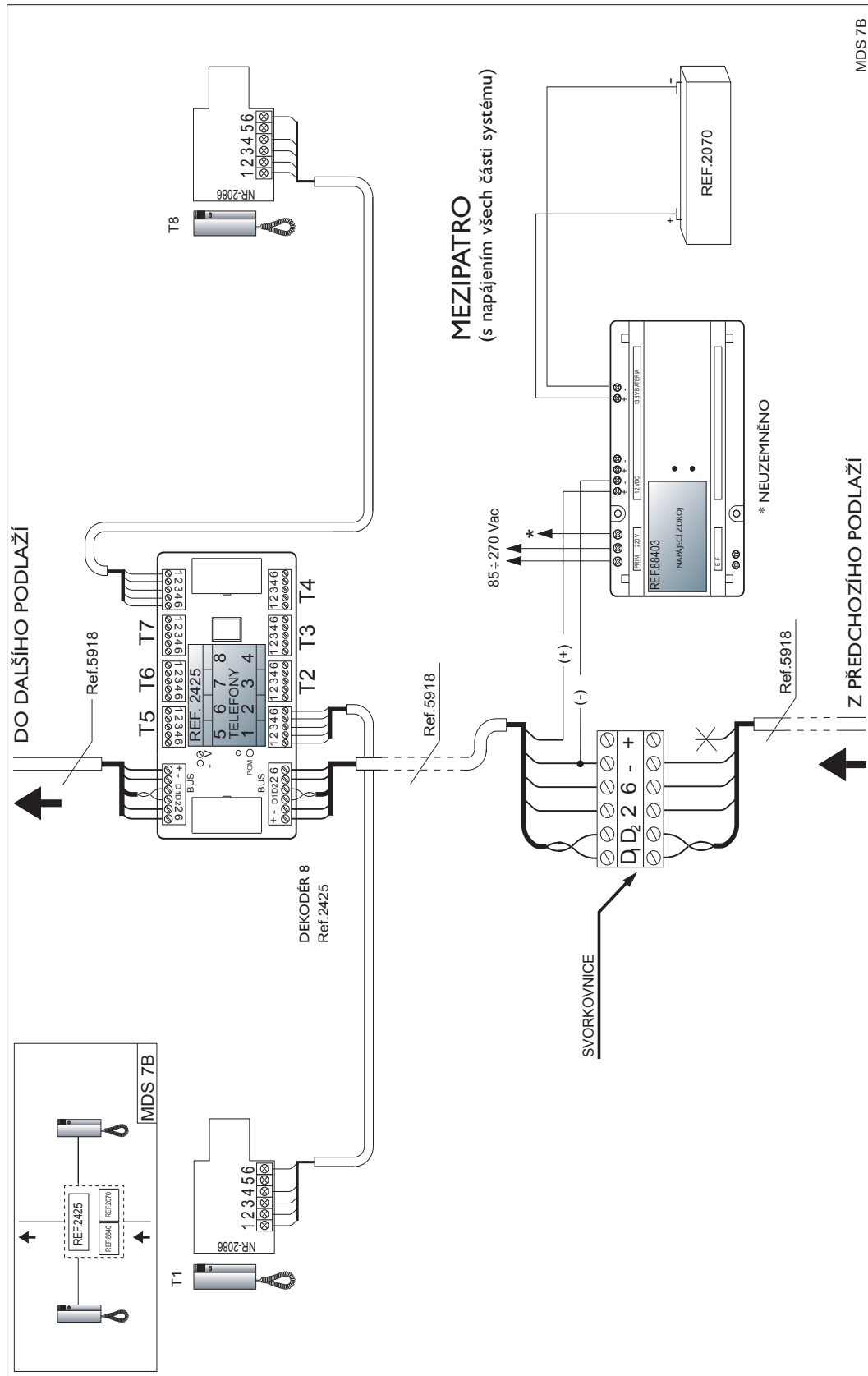

MDS 7B

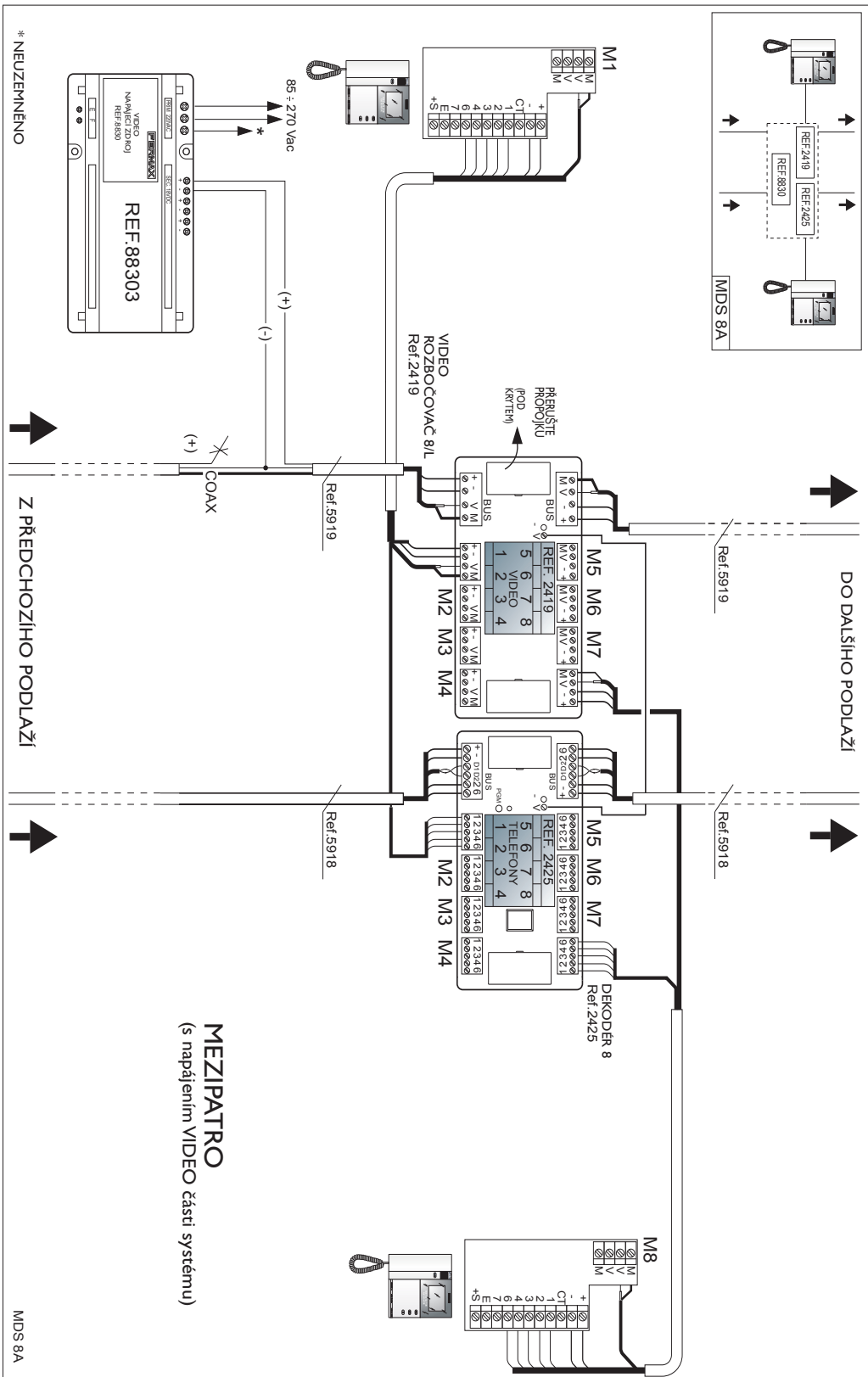

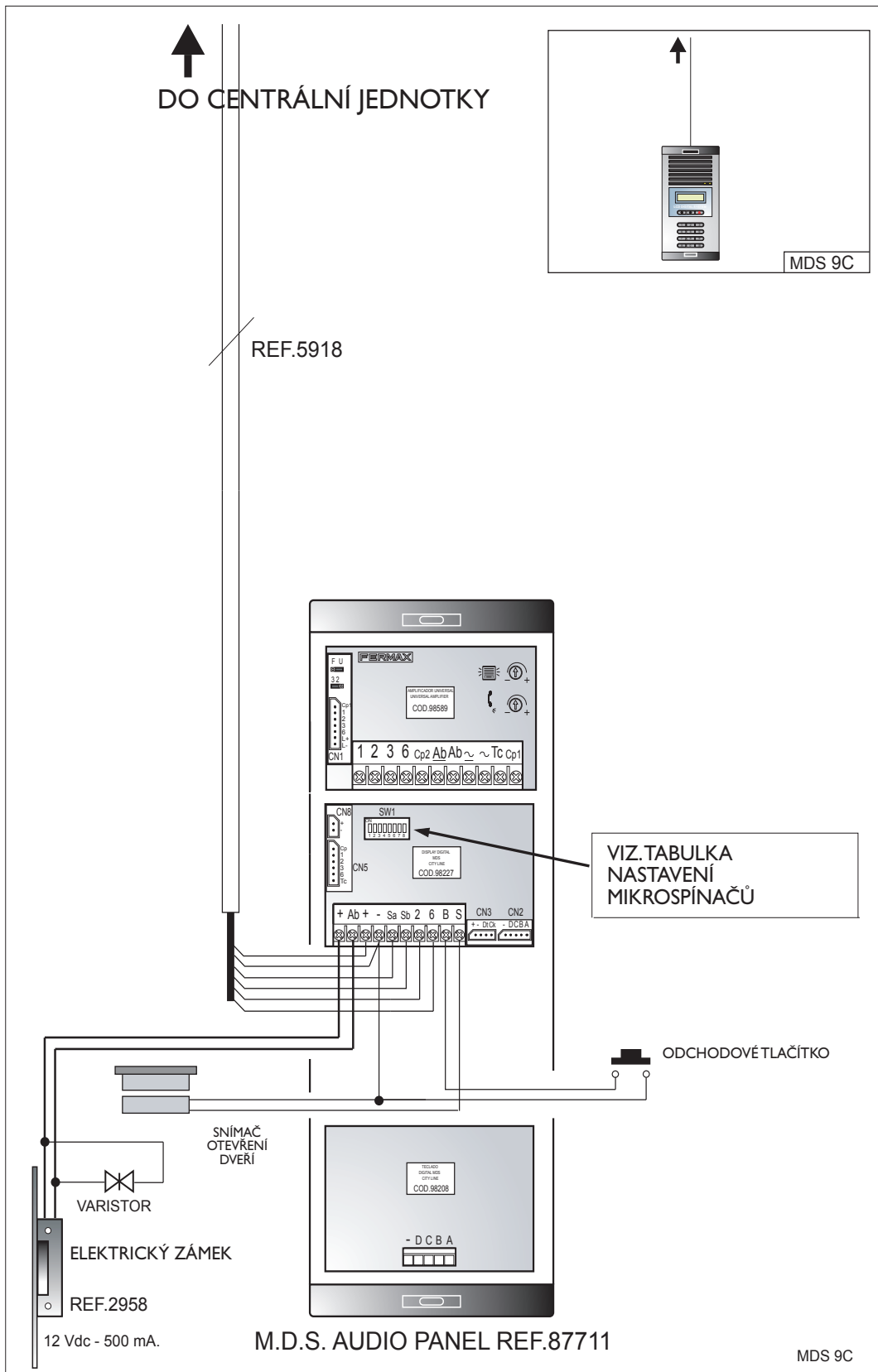

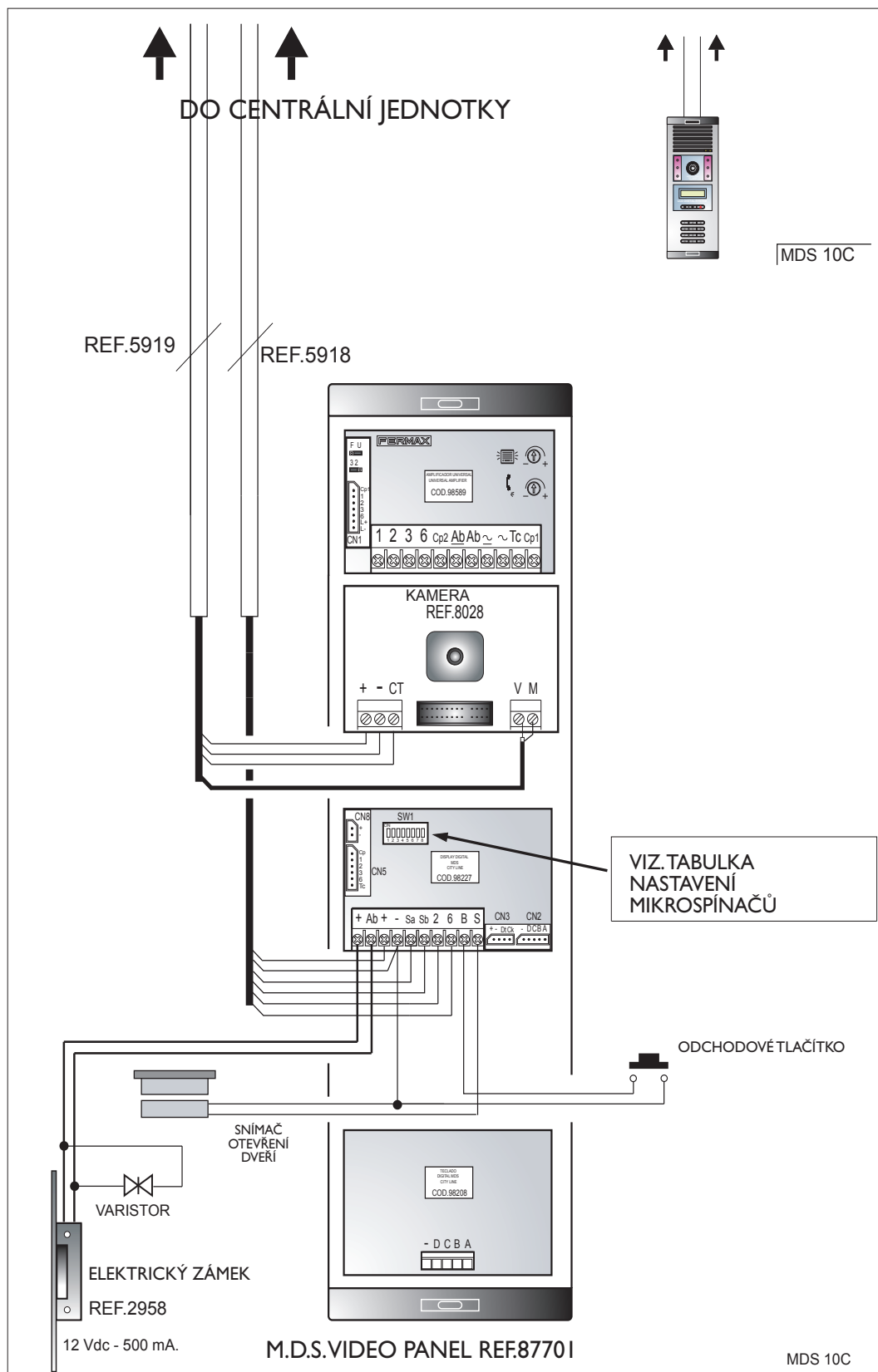

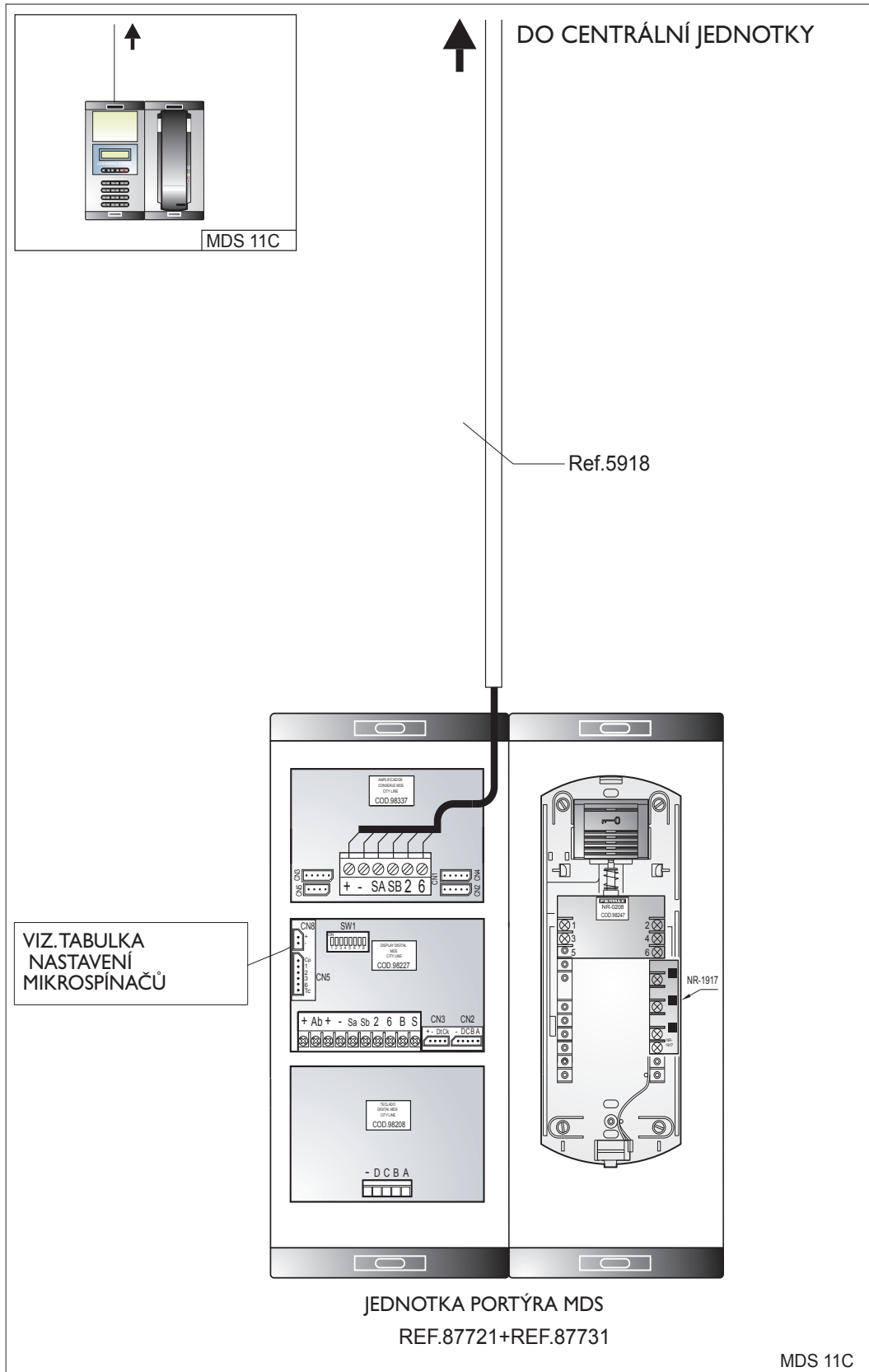

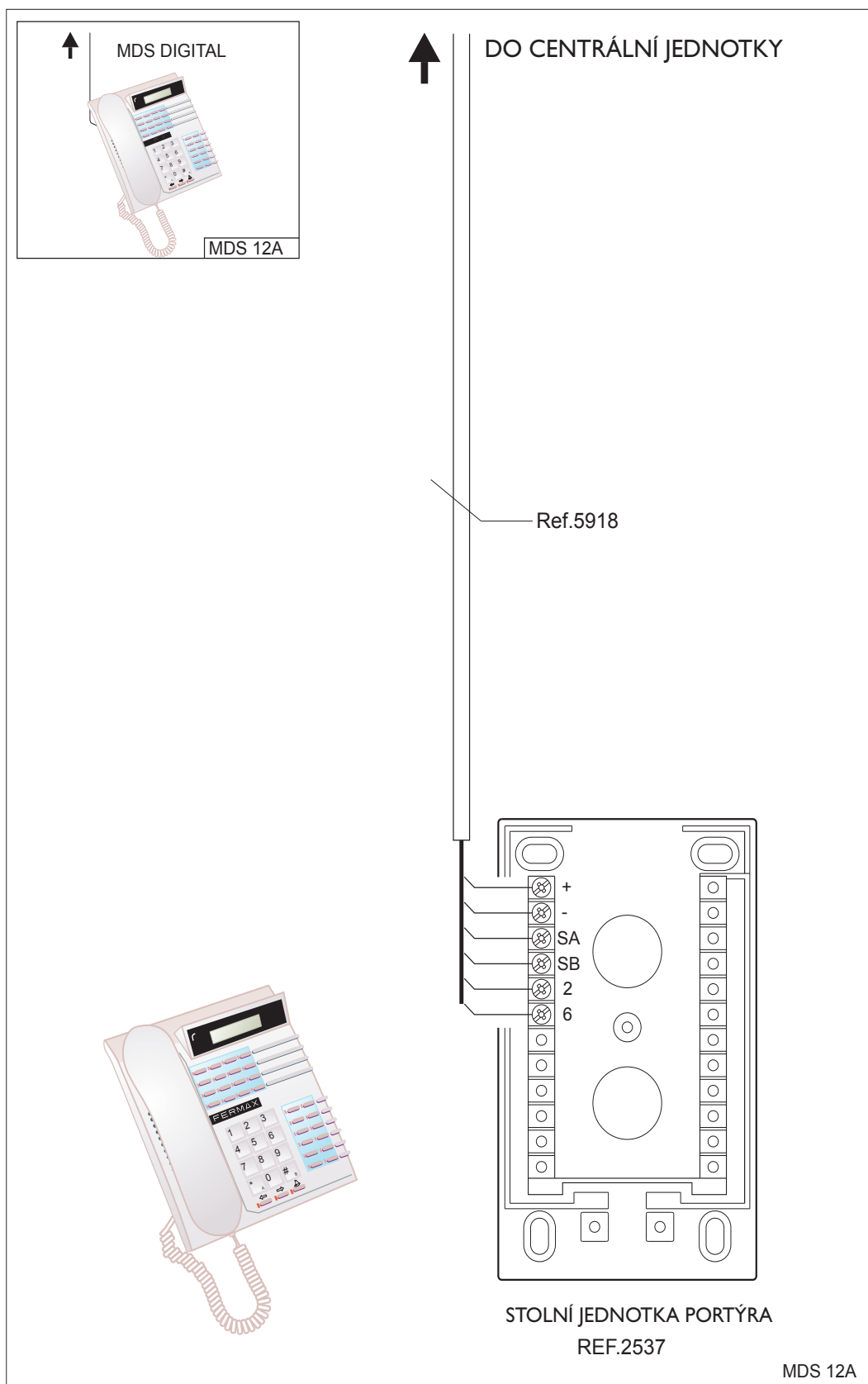

MDS 12A

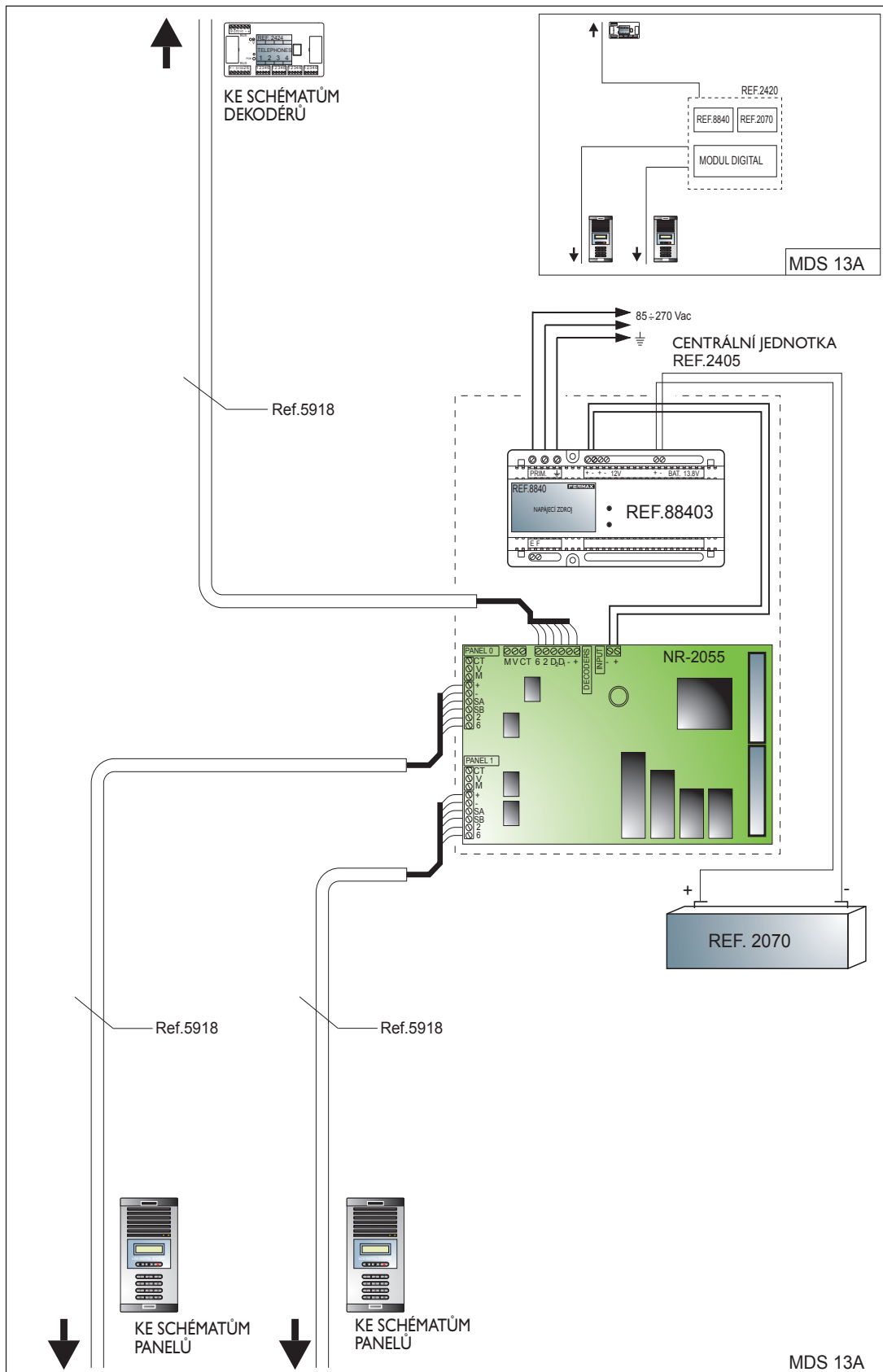

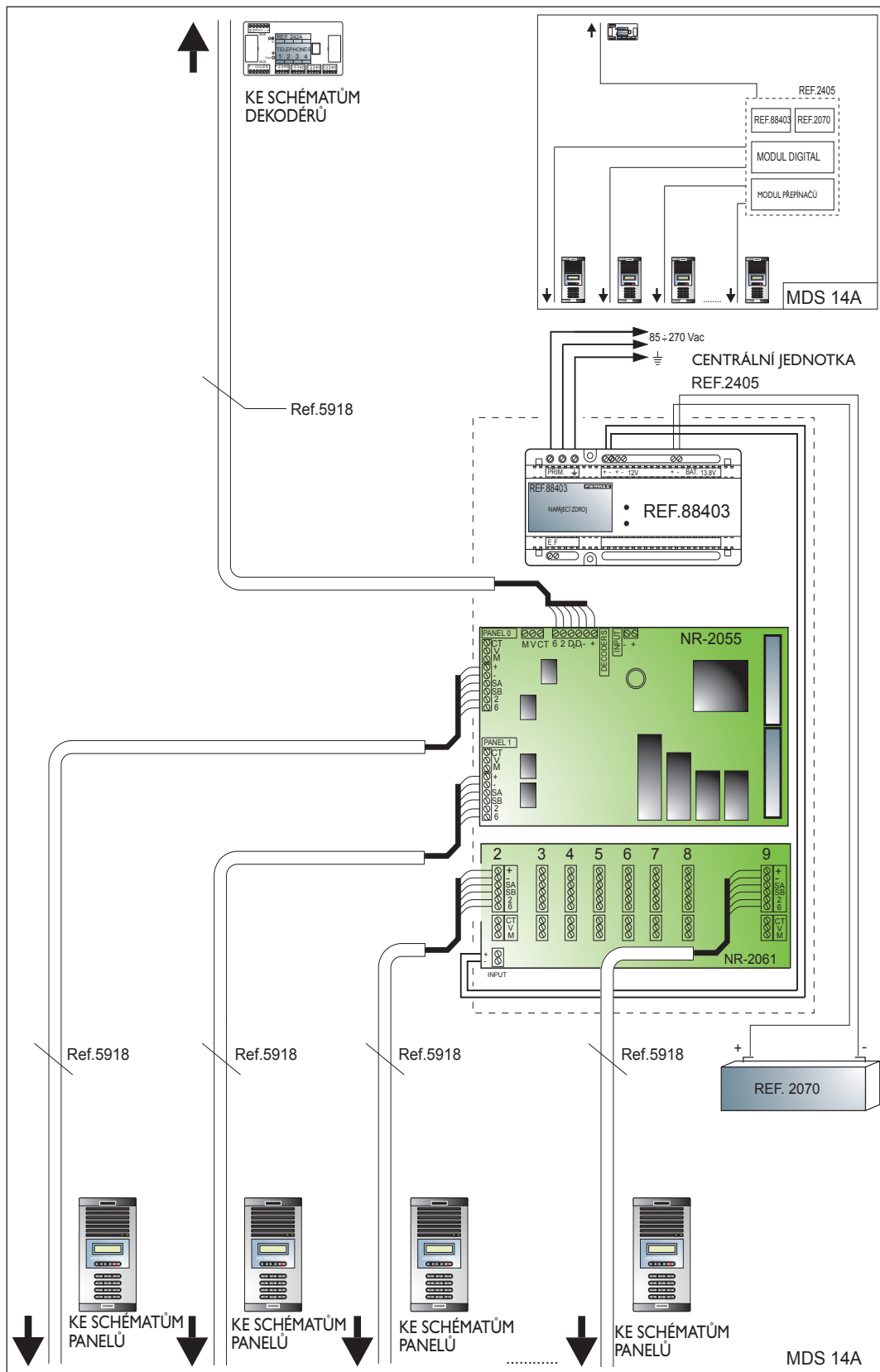

MDS 15A

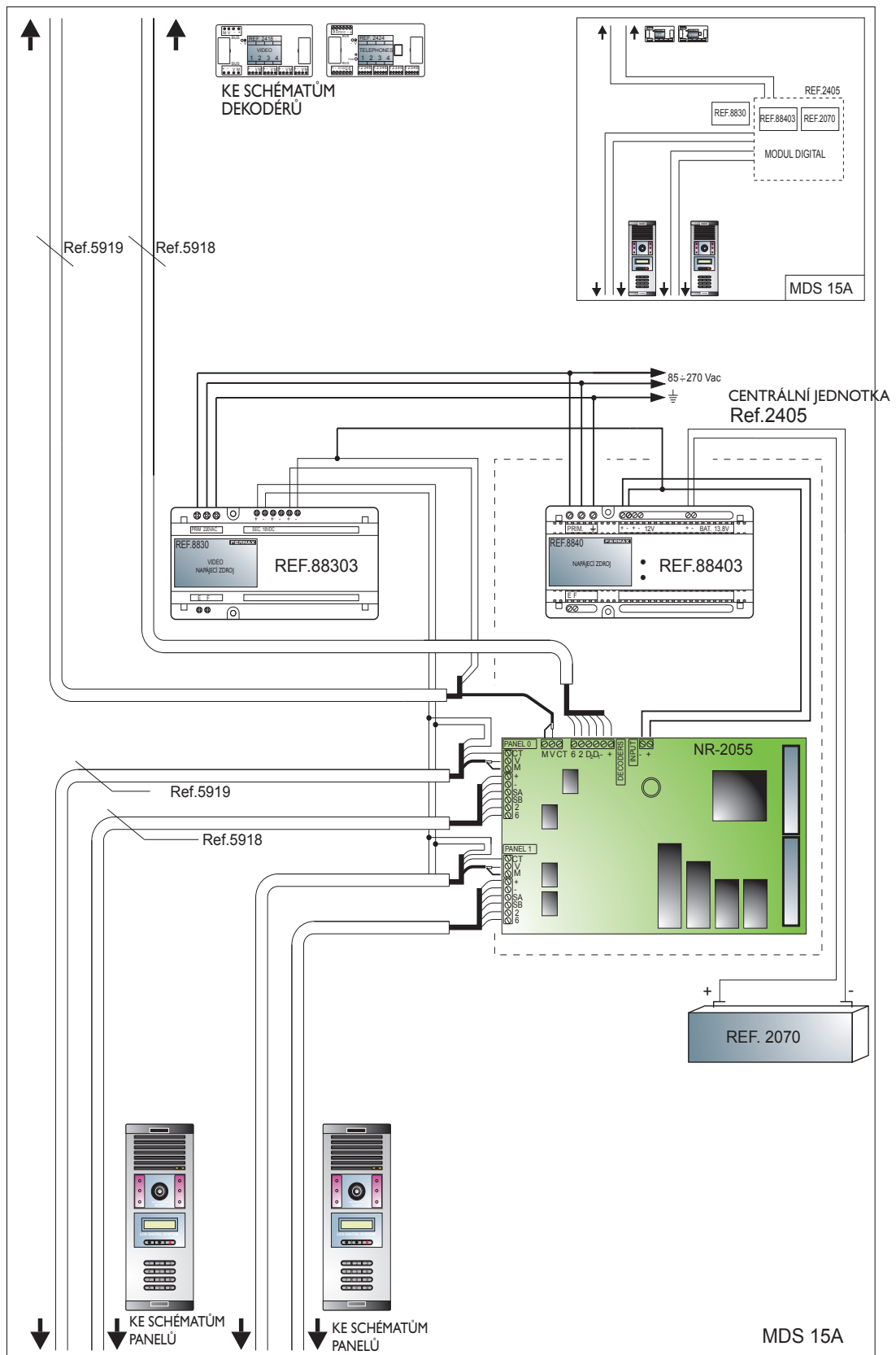

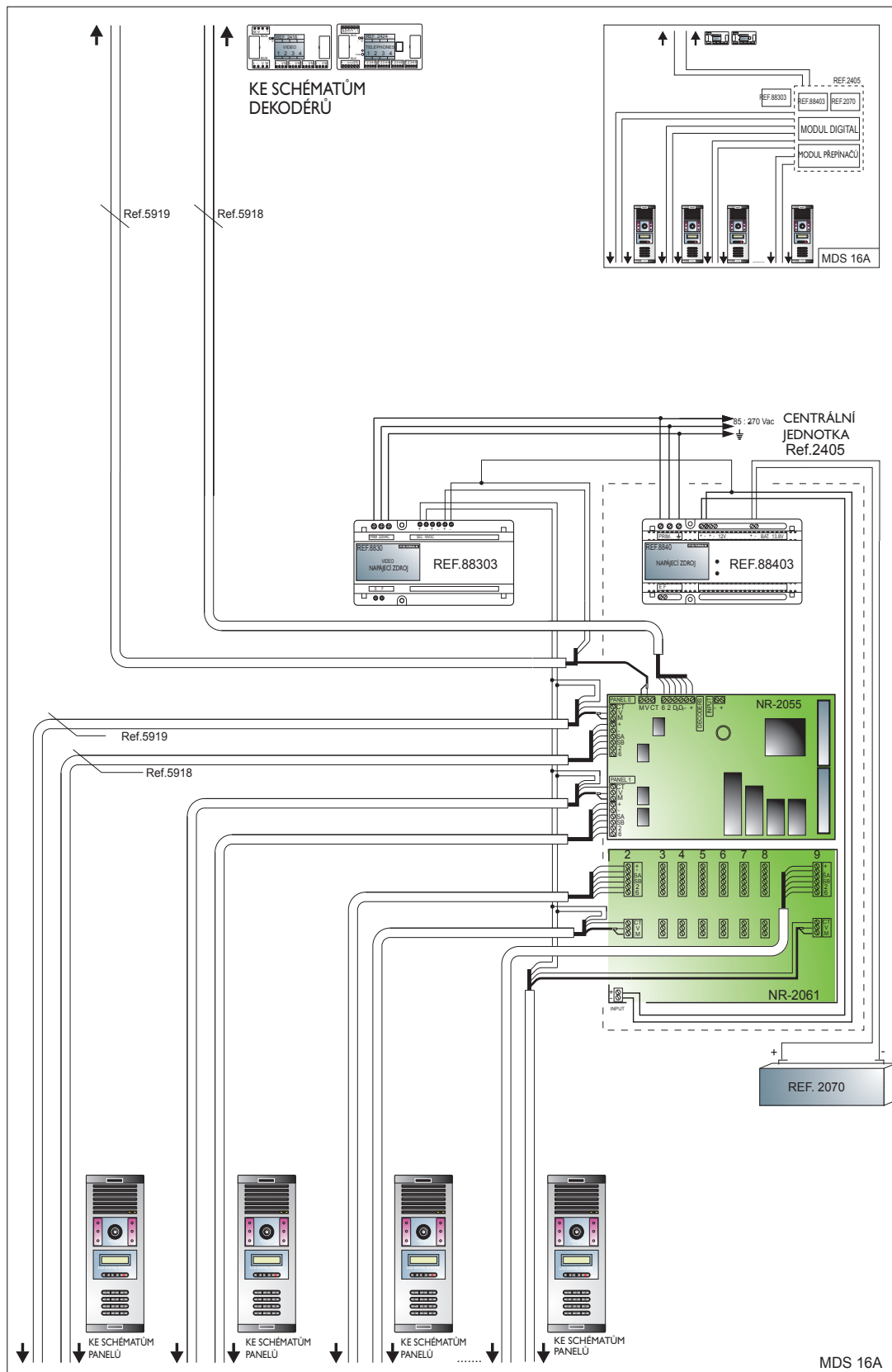

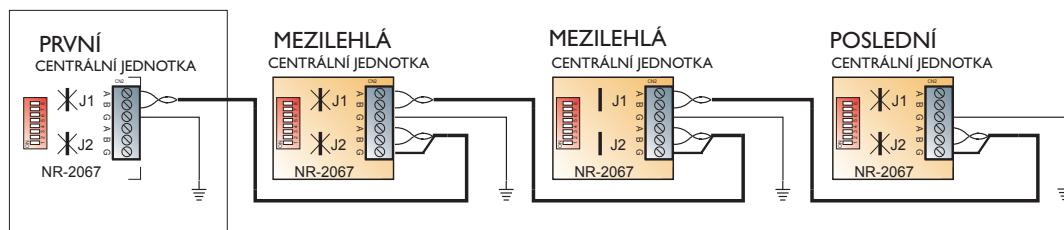
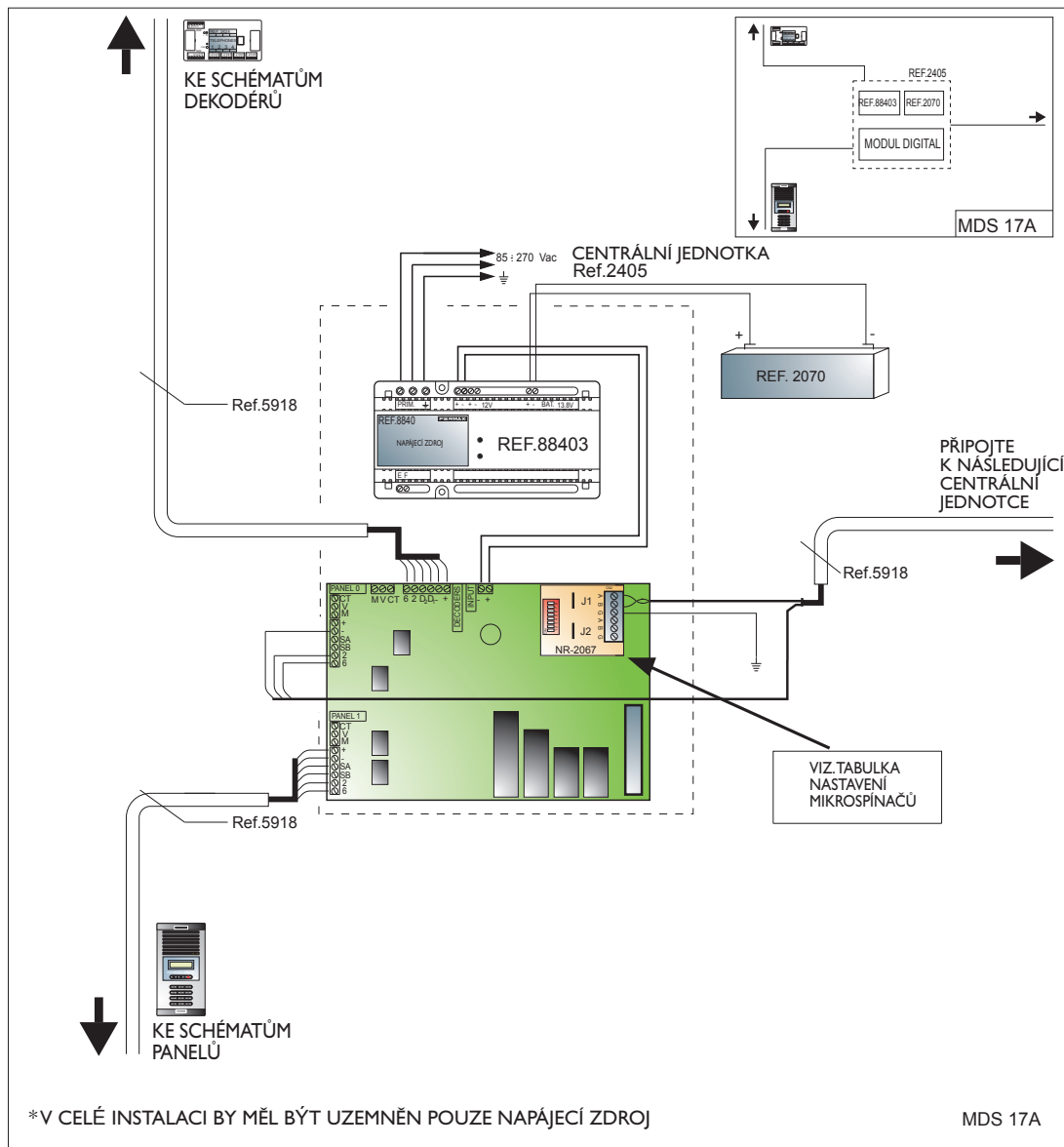

* STÍNĚNÍ KROUCENÉ DVOJLINKY SPOJUJÍCÍ DVĚ CENTRÁLNÍ JEDNOTKY MUSÍ BÝT UZEMNĚN POUZE V JEDNÉ CENTRÁLNÍ JEDNOTCE.

* U VŠECH CENTRÁLNÍCH JEDNOTEK, KROMĚ JEDNÉ Z MEZILEHLÝCH, PŘERUŠTE PROPOJKY J1 A J2.

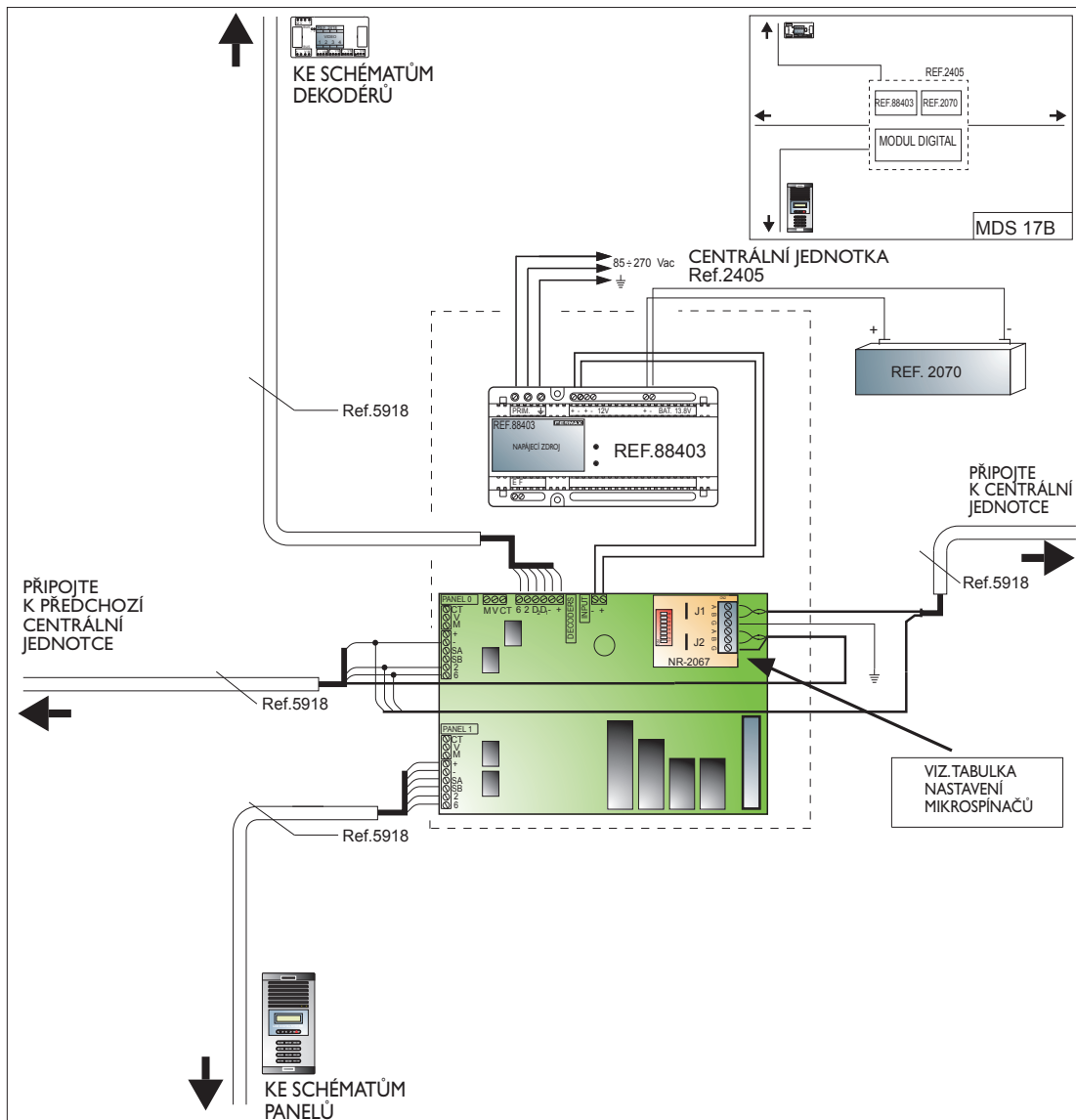

* V CELÉ INSTALACI BY MĚL BÝT UZEMNĚN POUZE NAPÁJECÍ ZDROJ

MDS 17B

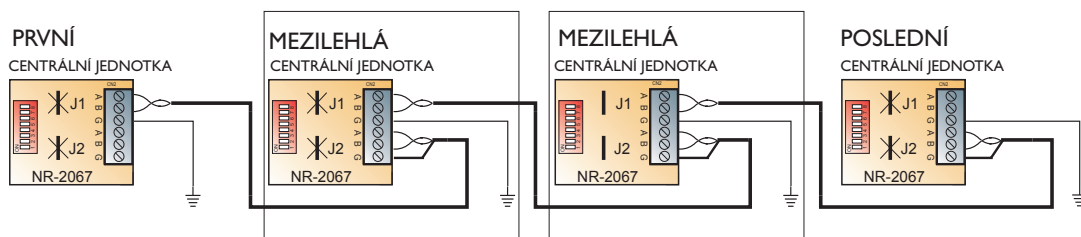

* STÍNĚNÍ KROUČENÉ DVOJLINKY SPOJUJÍCÍ DVĚ CENTRÁLNÍ JEDNOTKY MUSÍ BÝT UZEMNĚN POUZE V JEDNÉ CENTRÁLNÍ JEDNOTCE.

* U VŠECH CENTRÁLNÍCH JEDNOTEK, KROMĚ JEDNÉ Z MEZILEHLÝCH, PŘERUŠTE PROPOJKY J1 A J2.

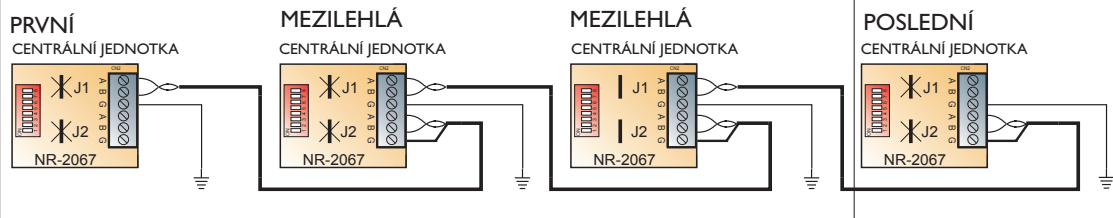
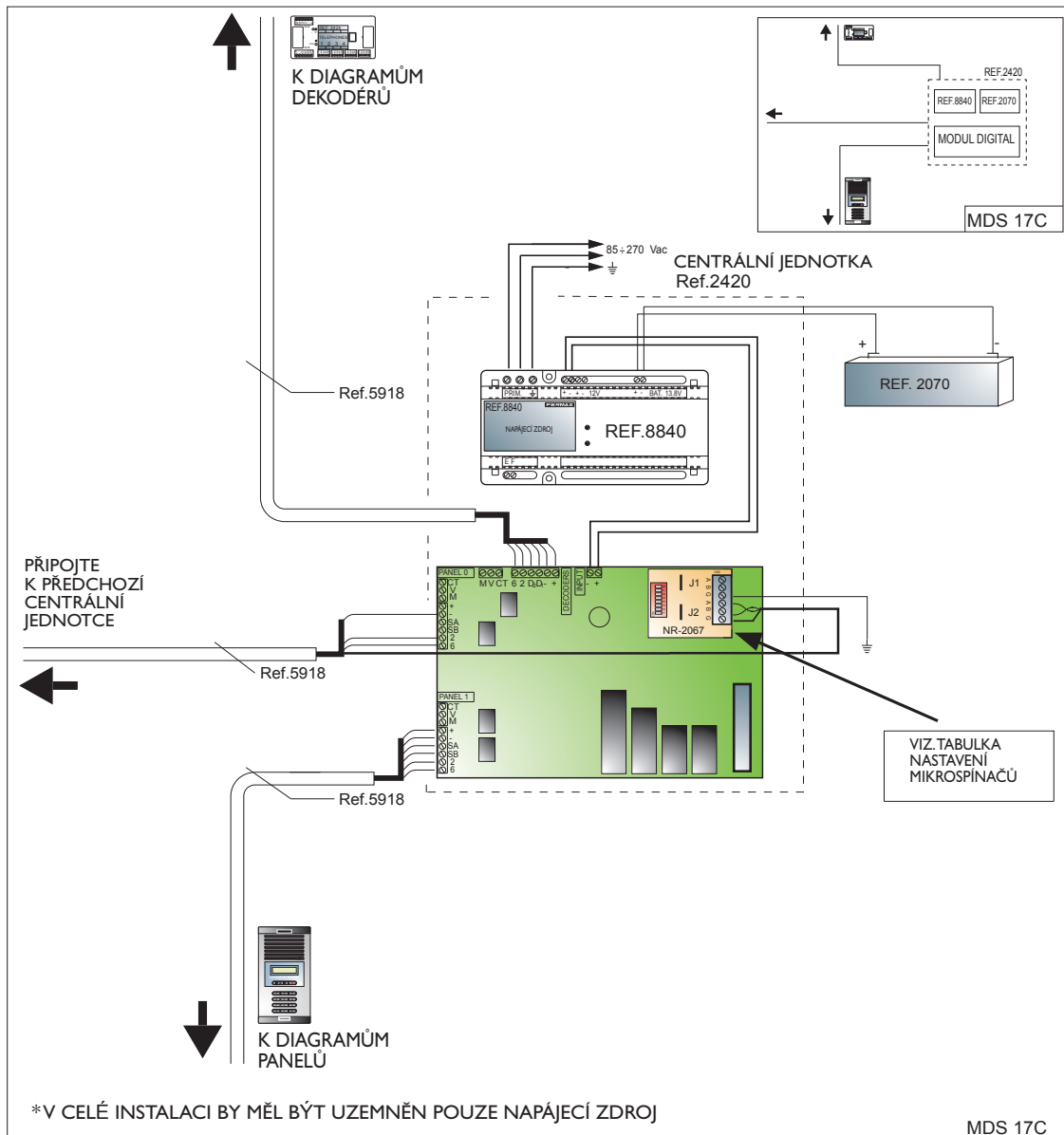

* STÍNĚNÍ KROUČENÉ DVOJLINKY SPOJJÍCÍ DVĚ CENTRÁLNÍ JEDNOTKY MUSÍ BÝT UZEMNĚN POUZE V JEDNÉ CENTRÁLNÍ JEDNOTCE.

* U VŠECH CENTRÁLNÍCH JEDNOTEK, KROMĚ JEDNÉ Z MEZILEHLÝCH, PŘERUŠTE PROPOJKY J1 A J2.

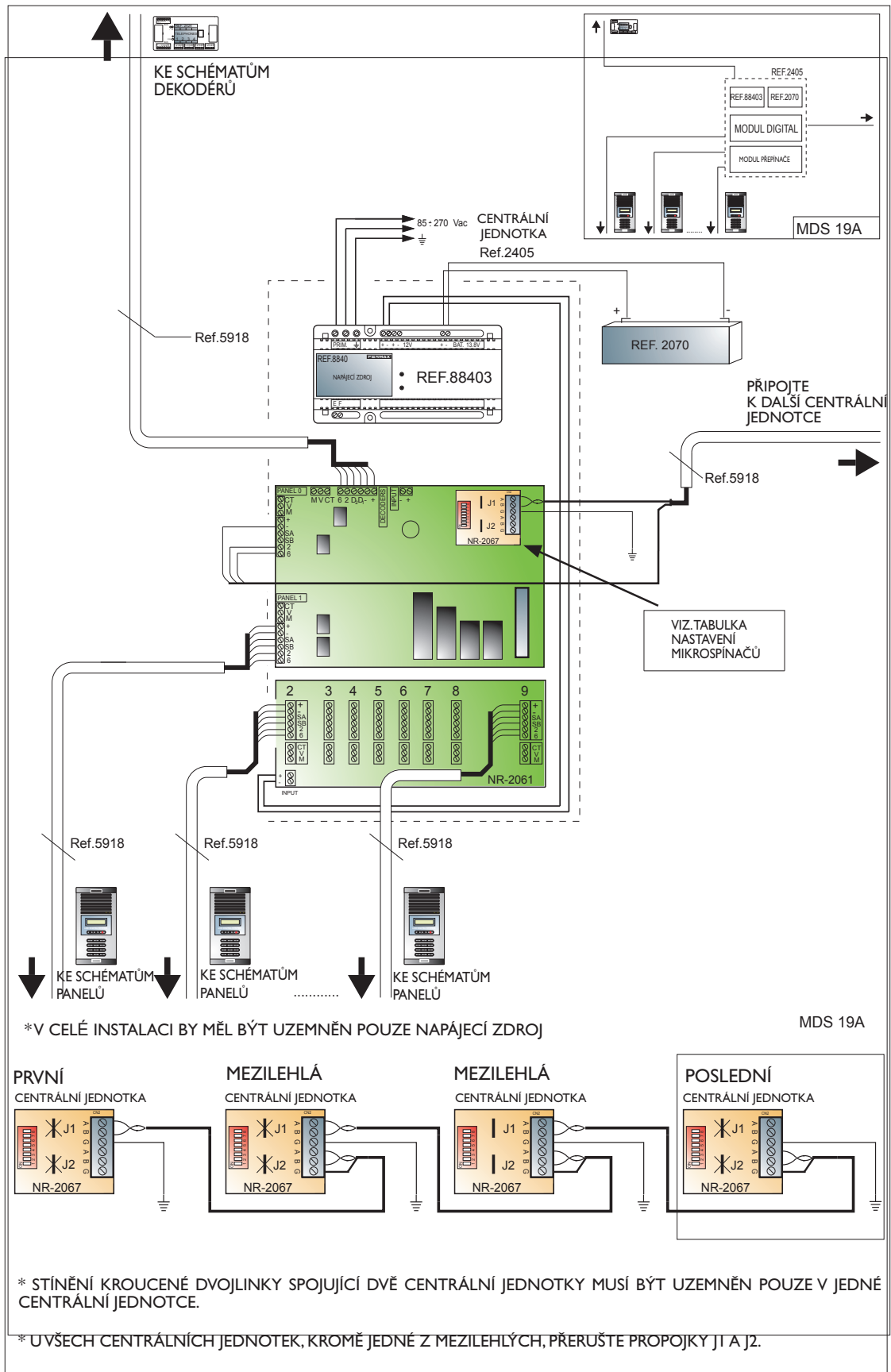

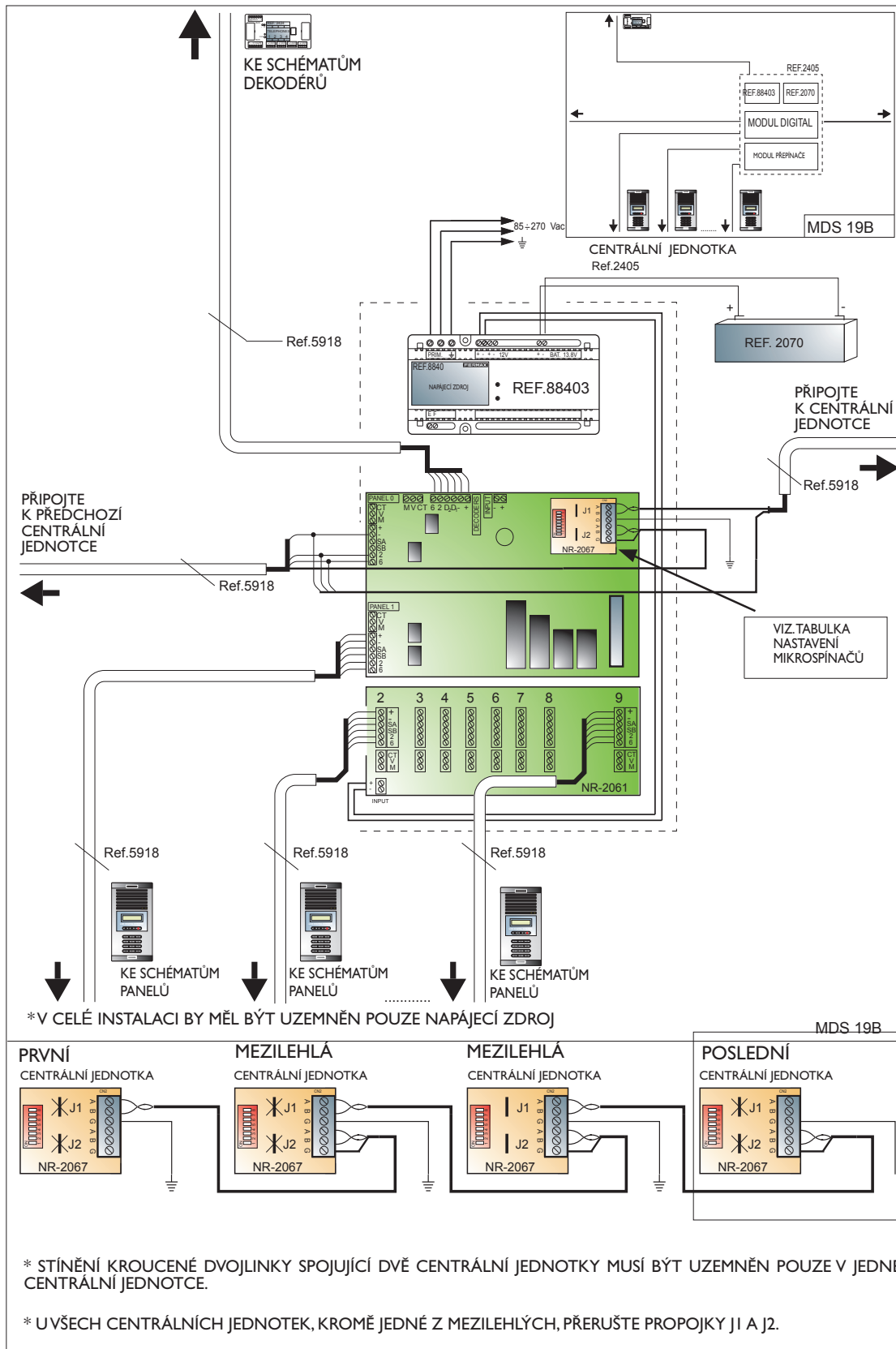

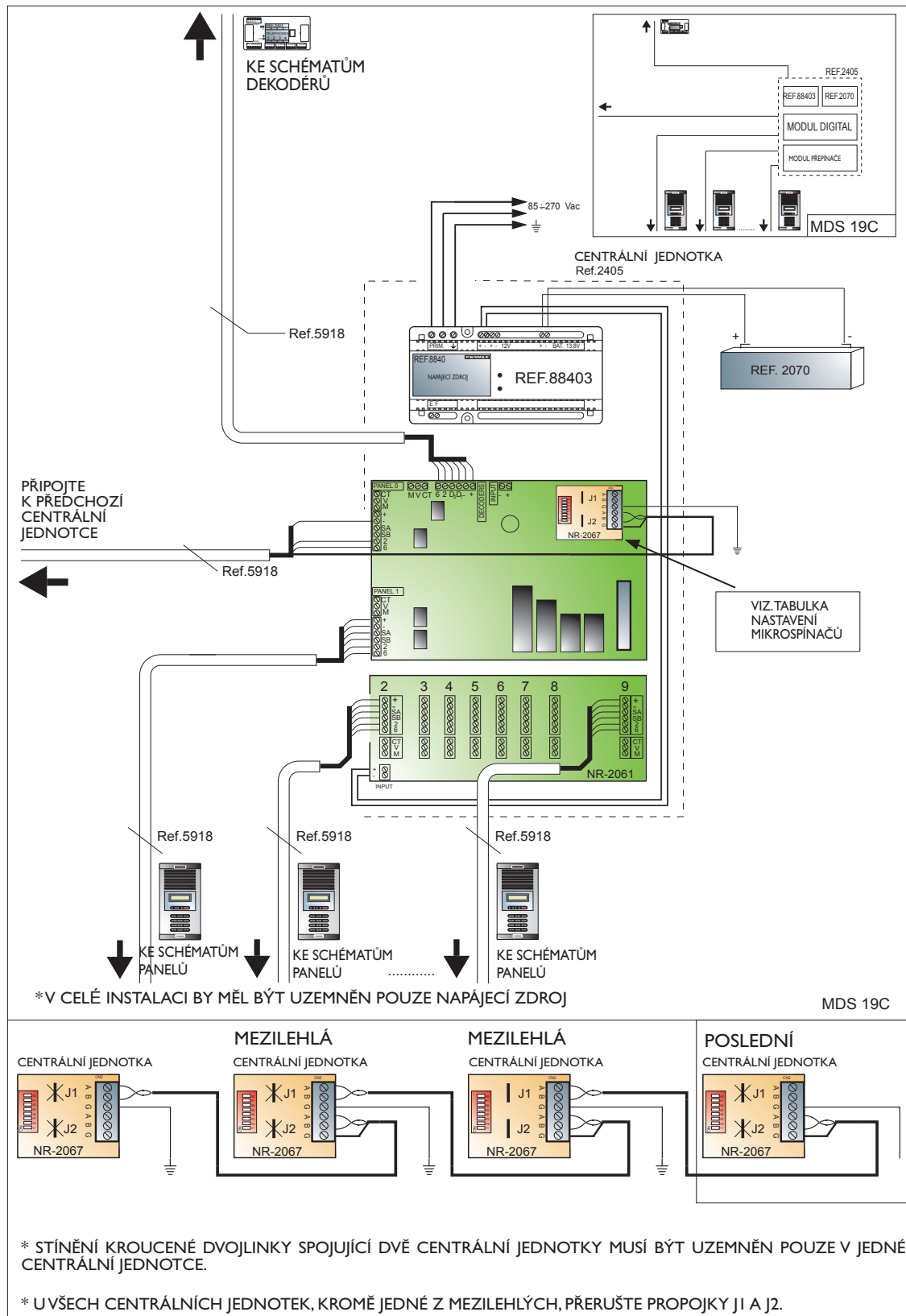

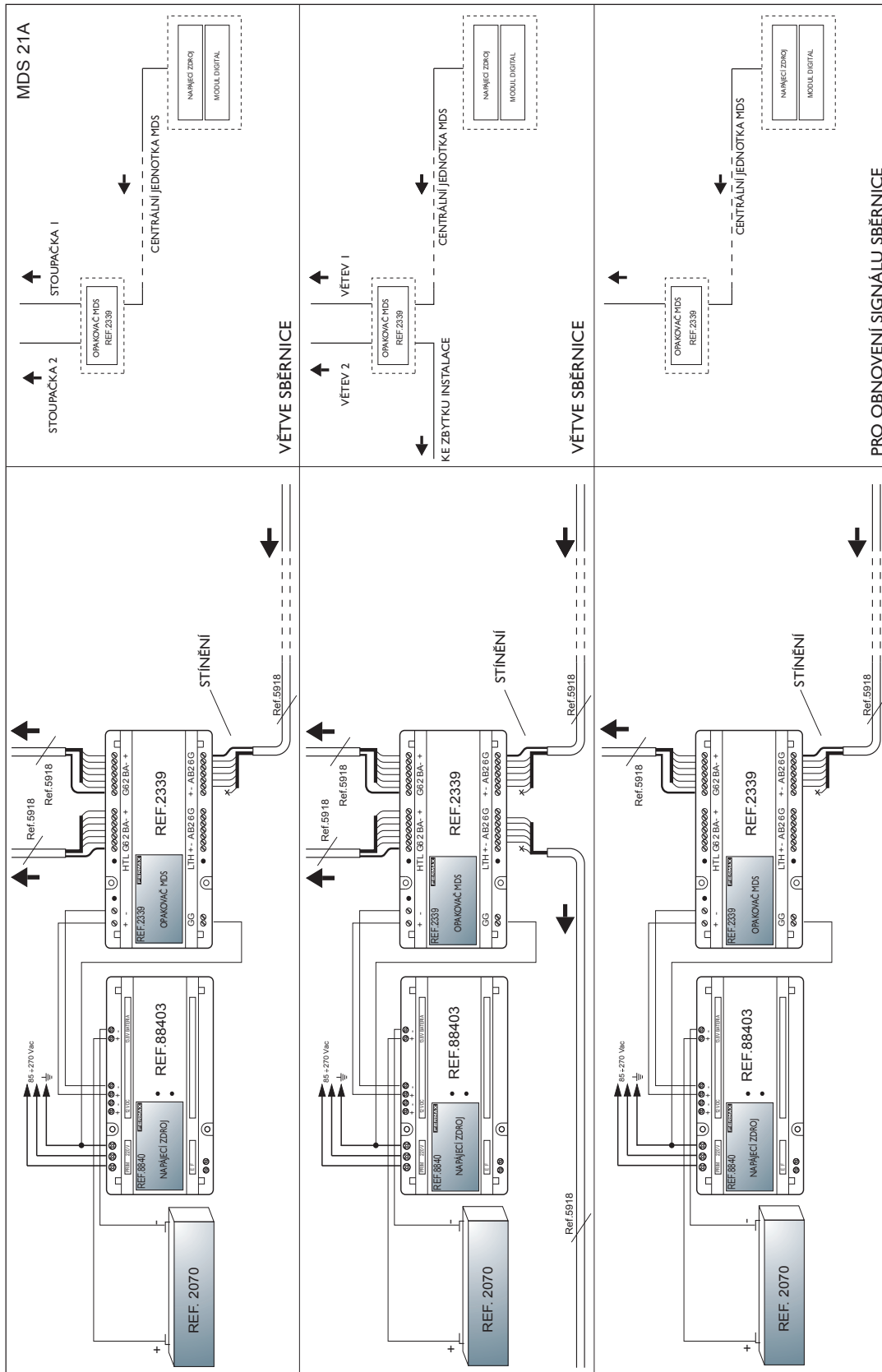

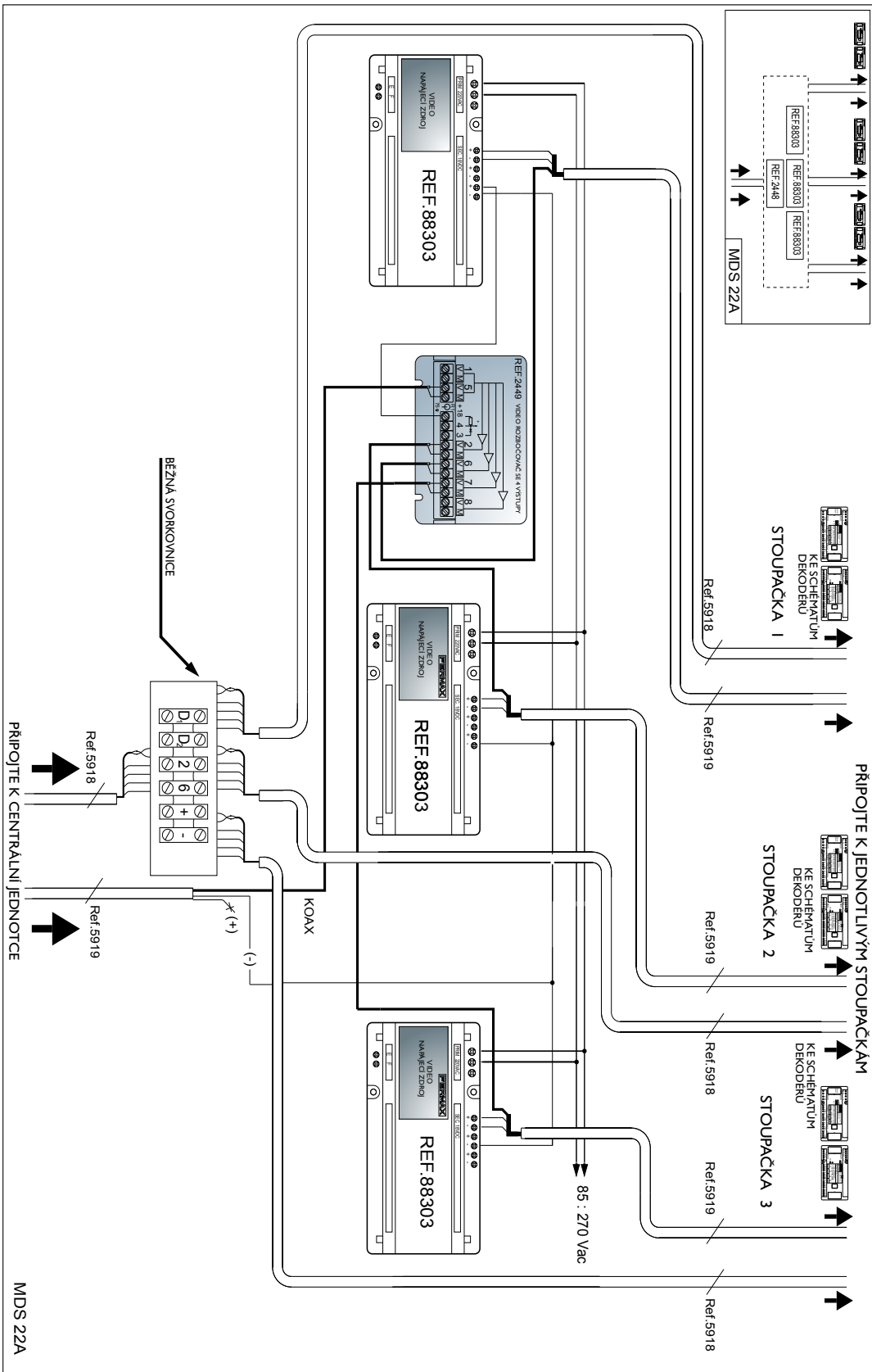

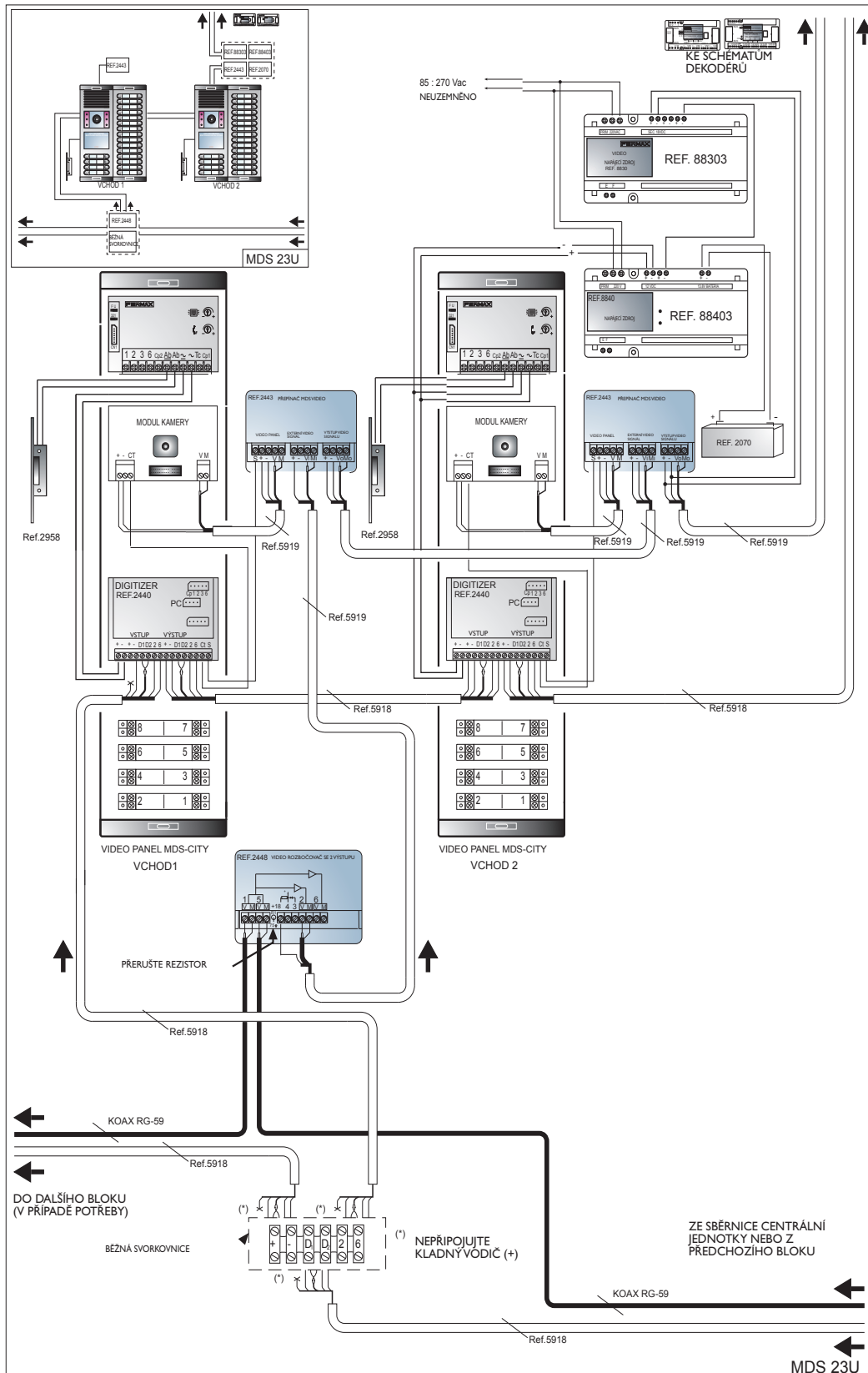

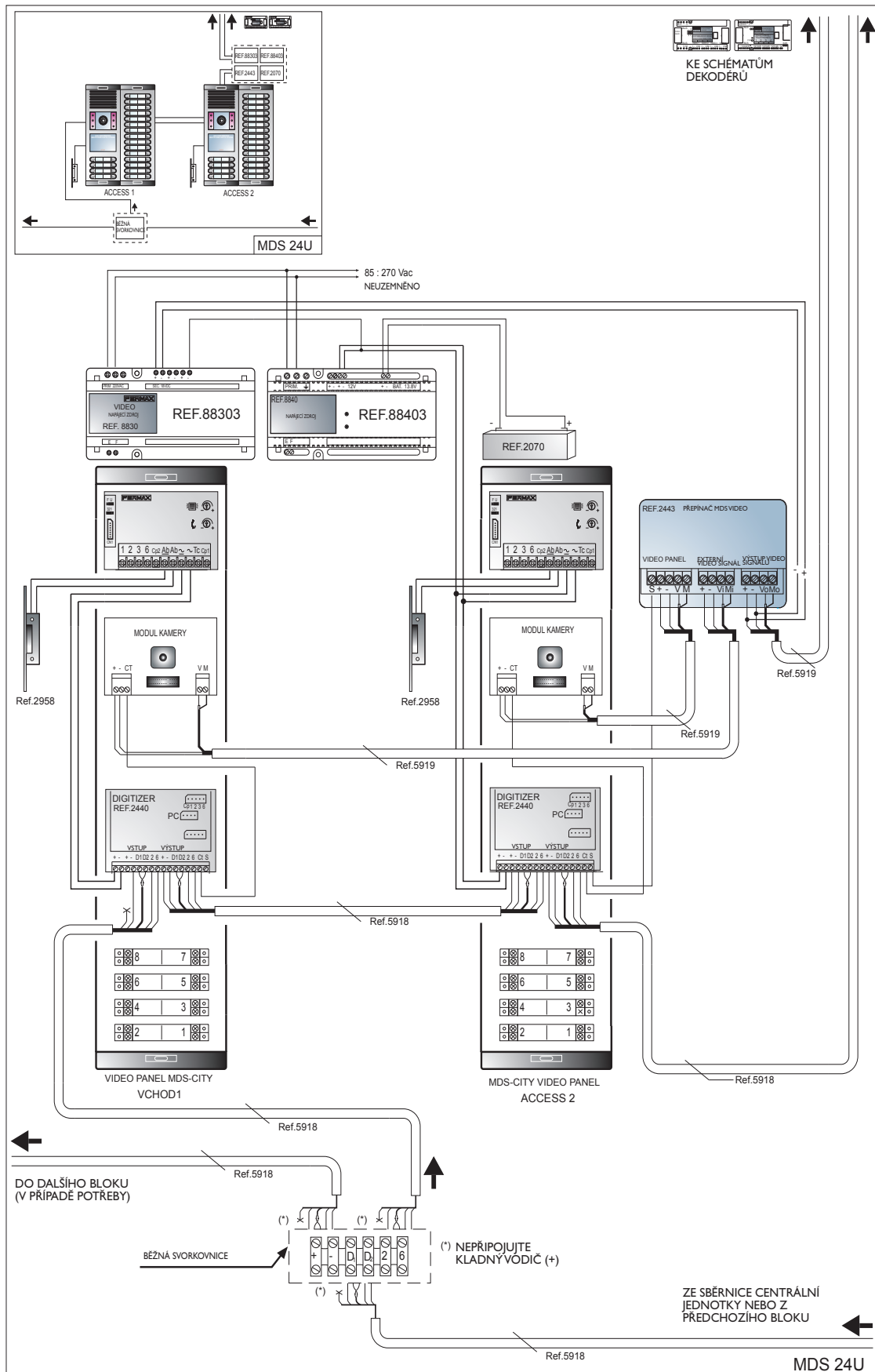

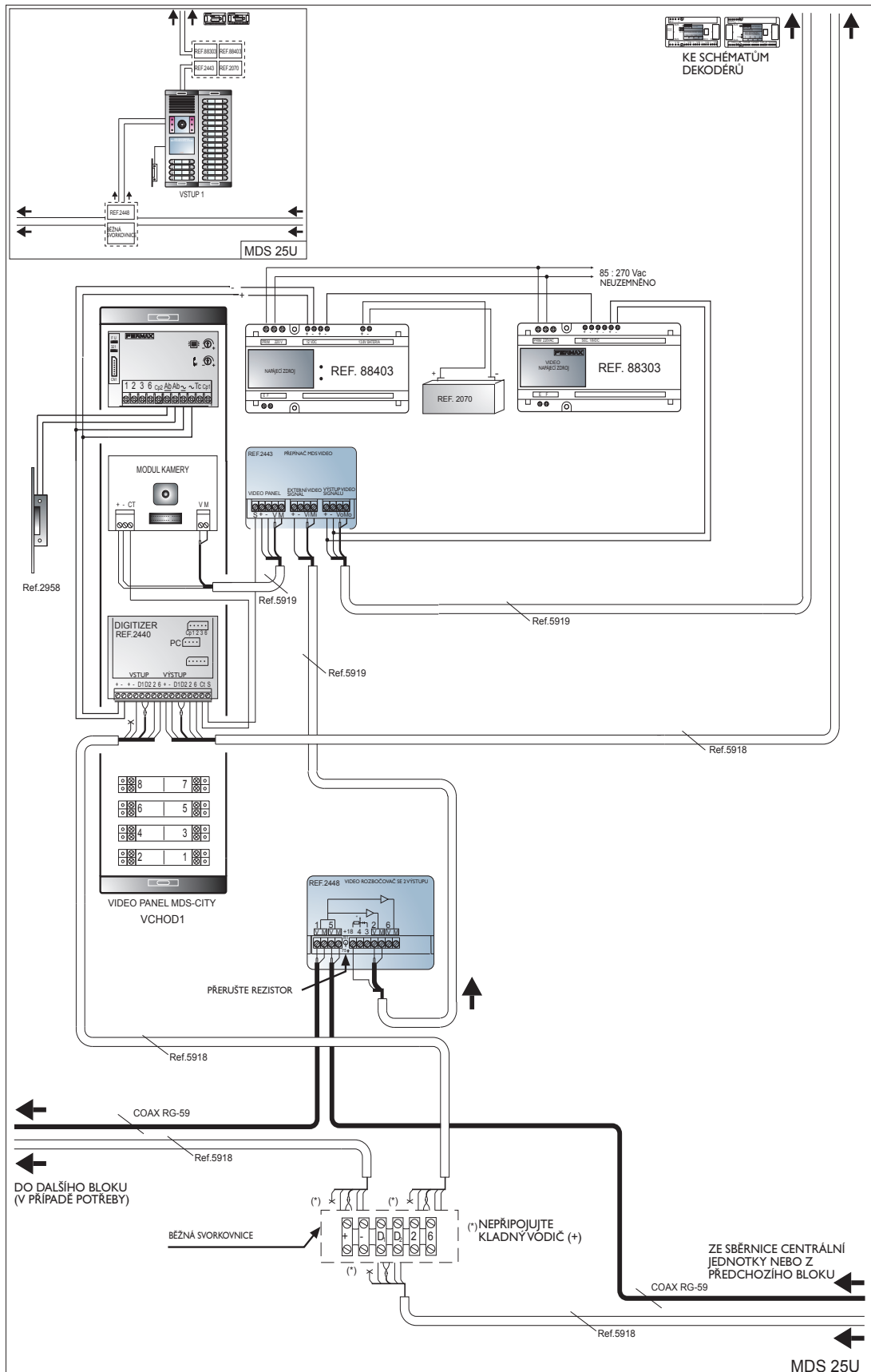

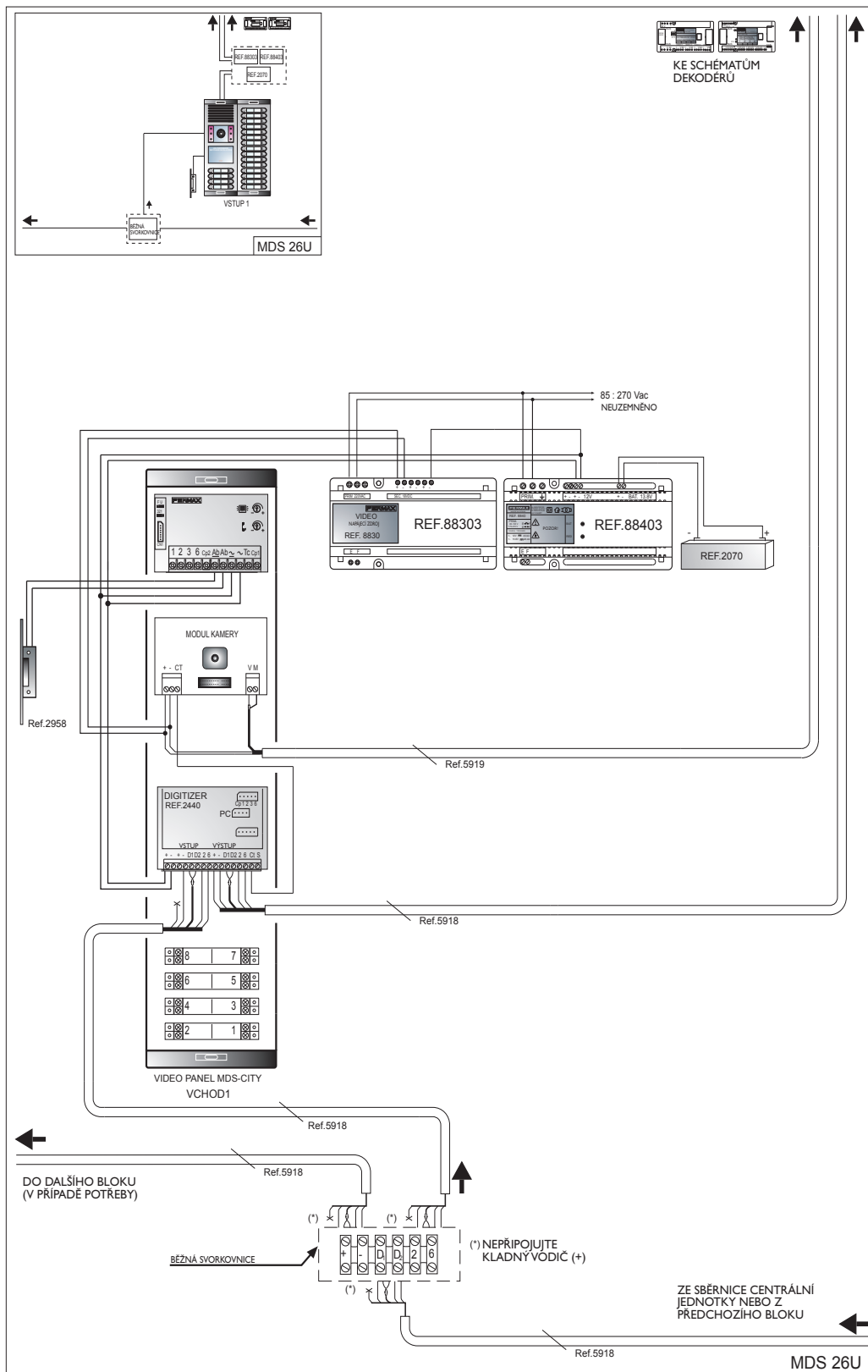

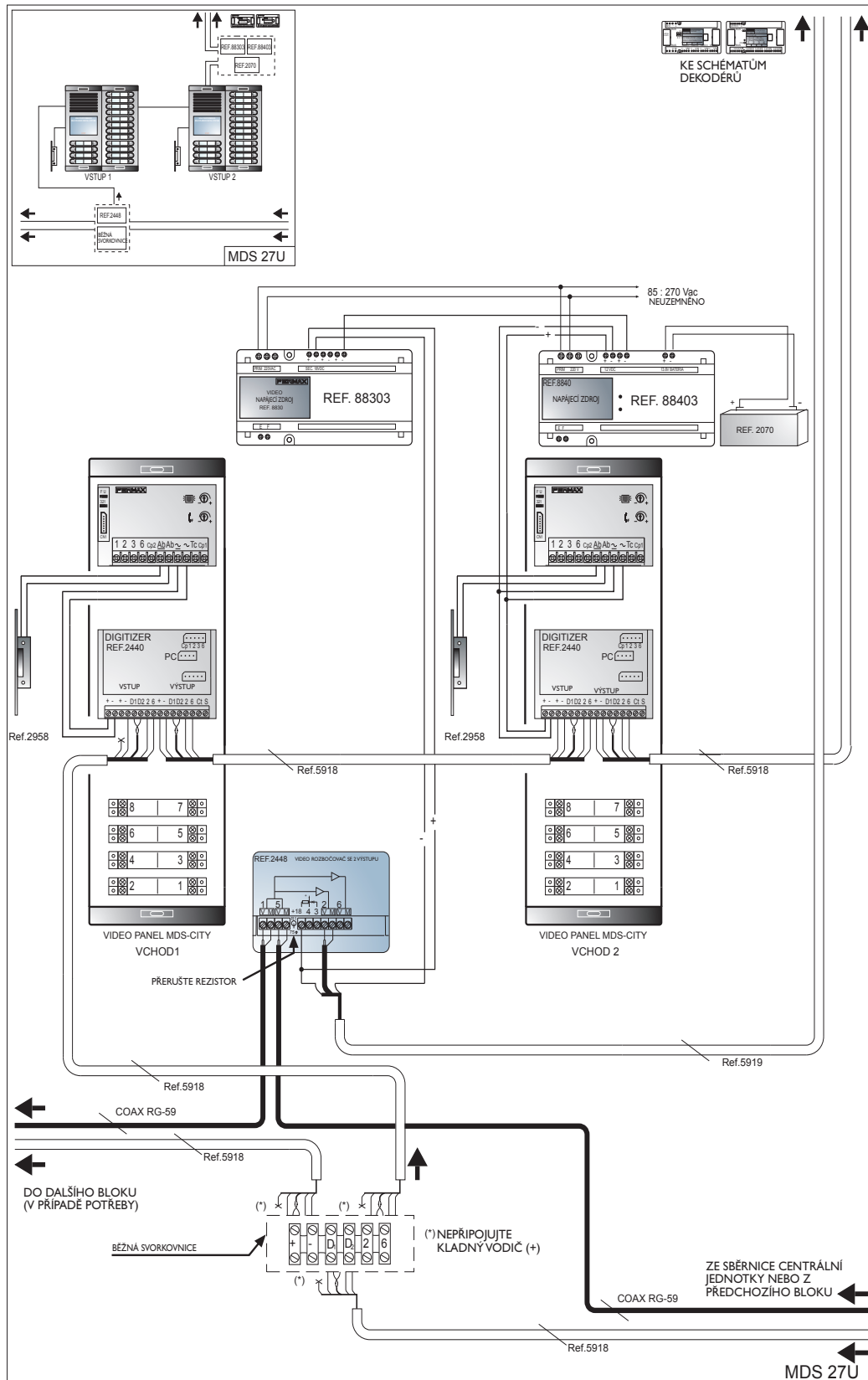

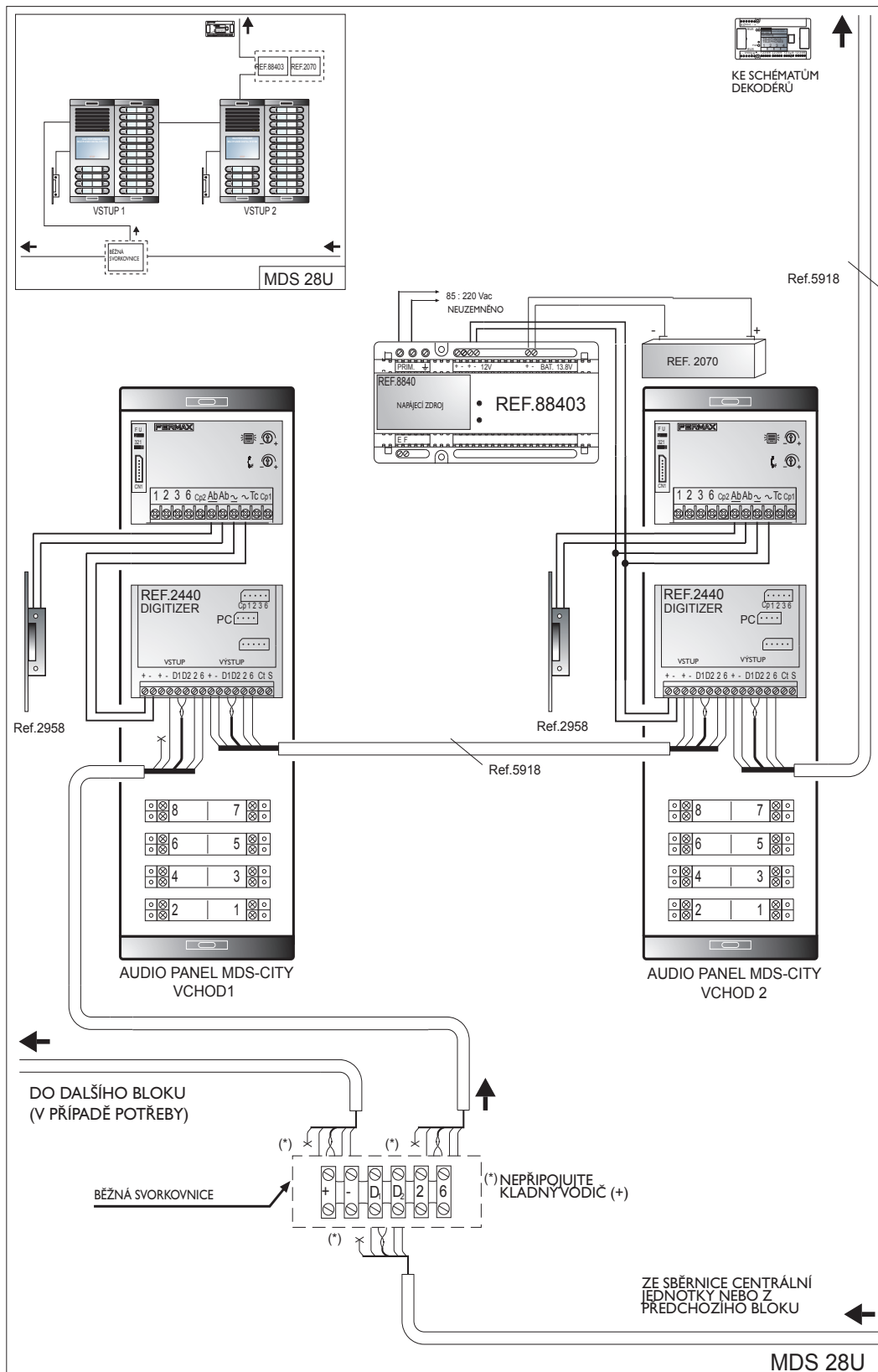

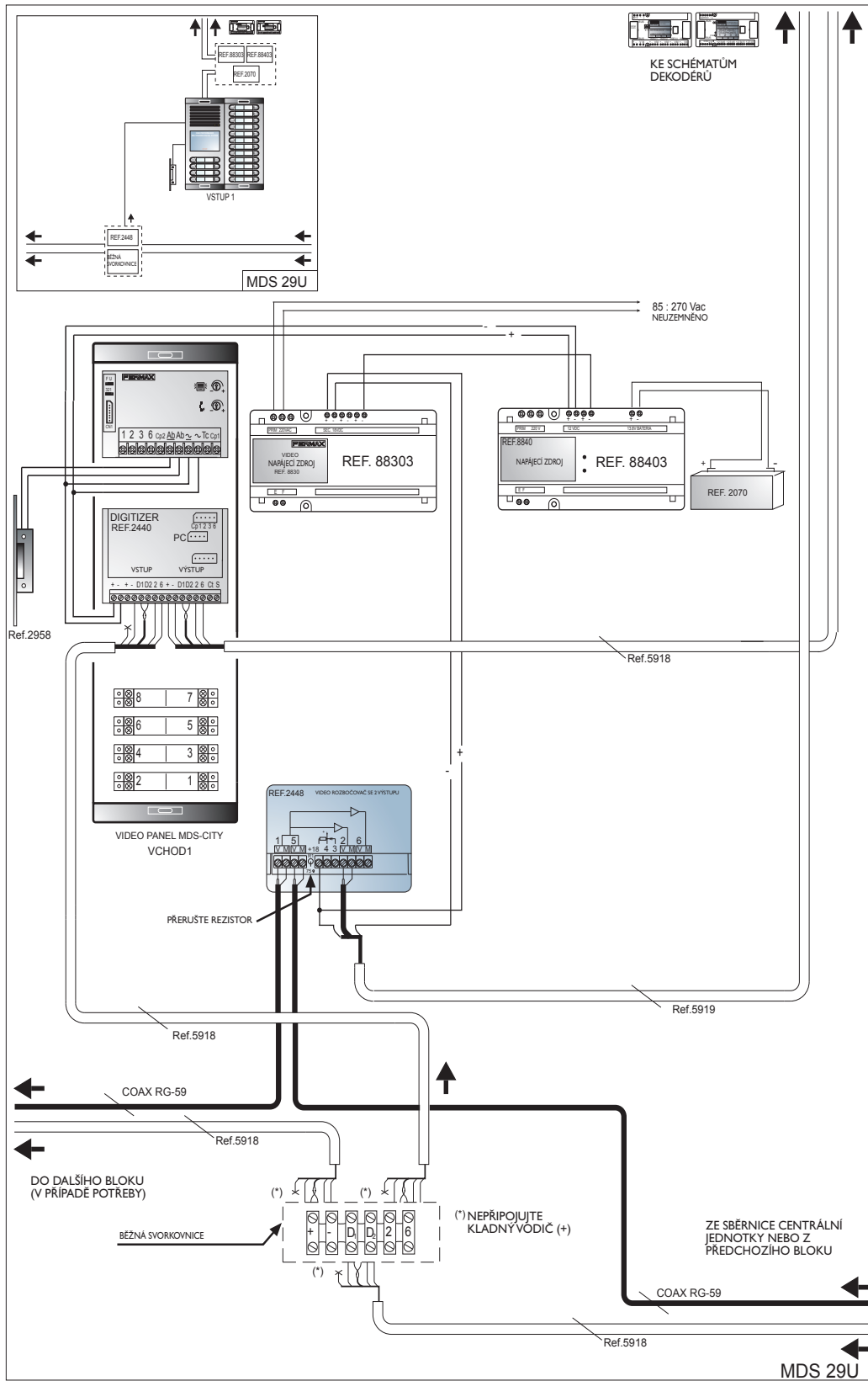

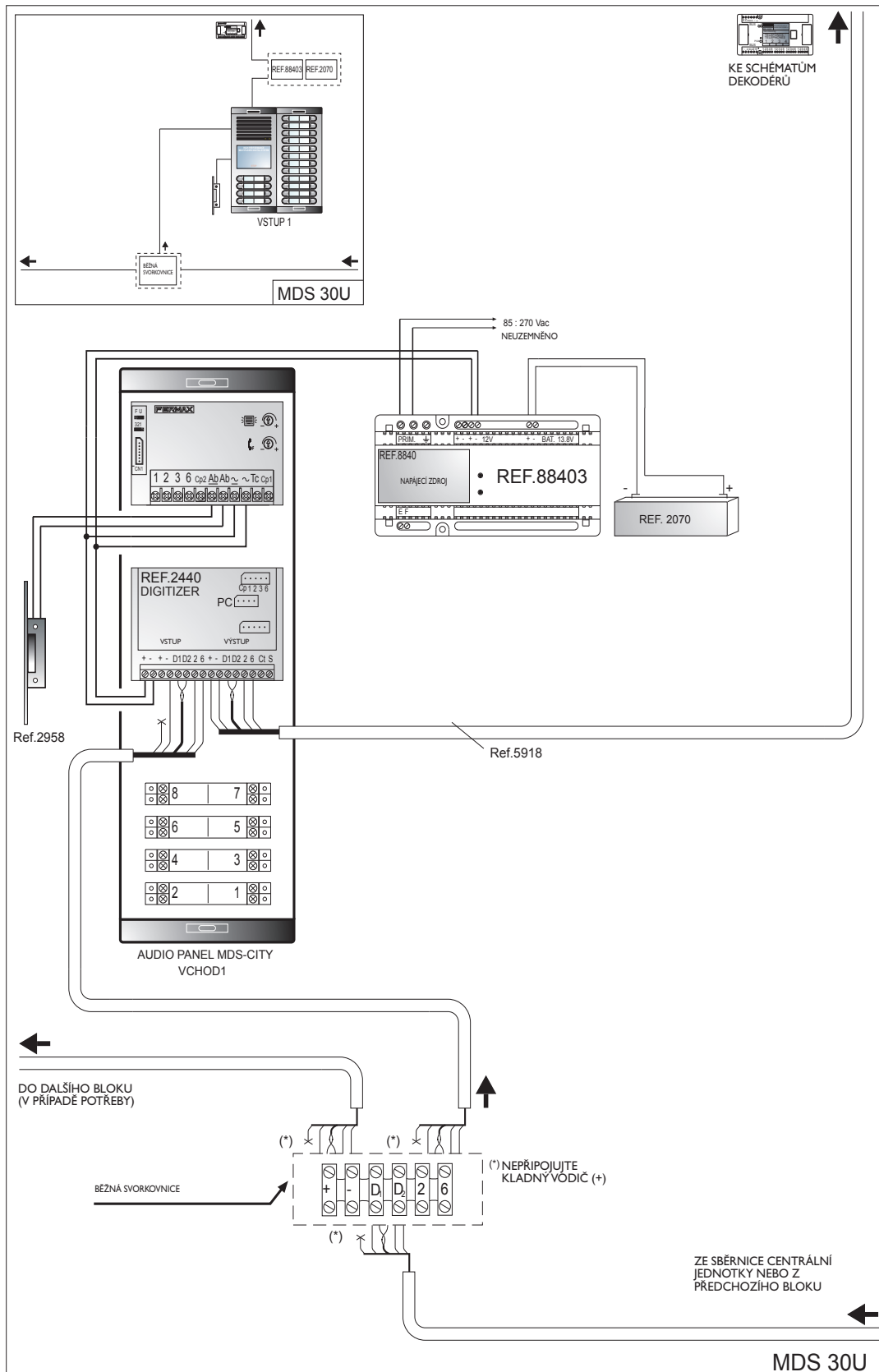

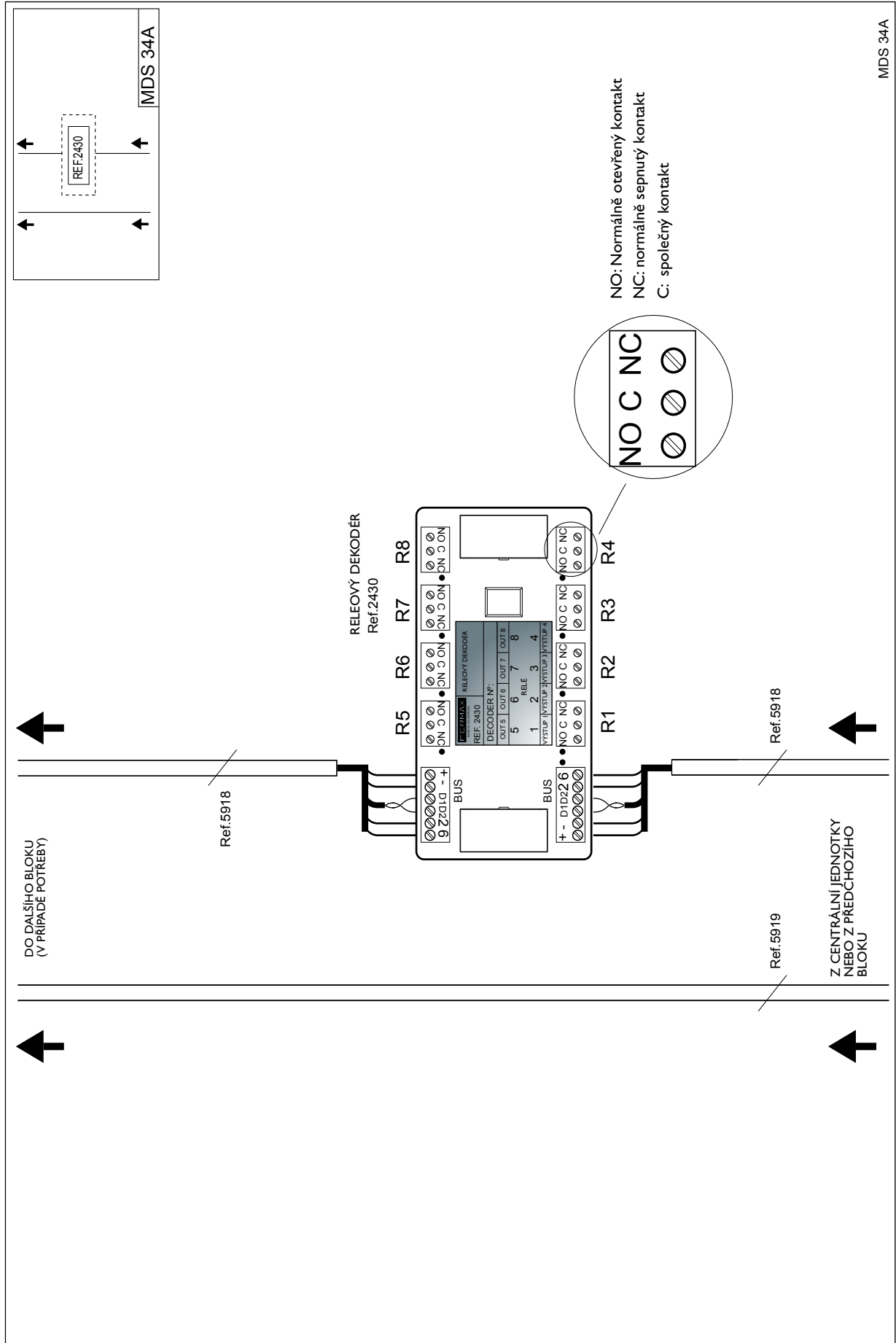

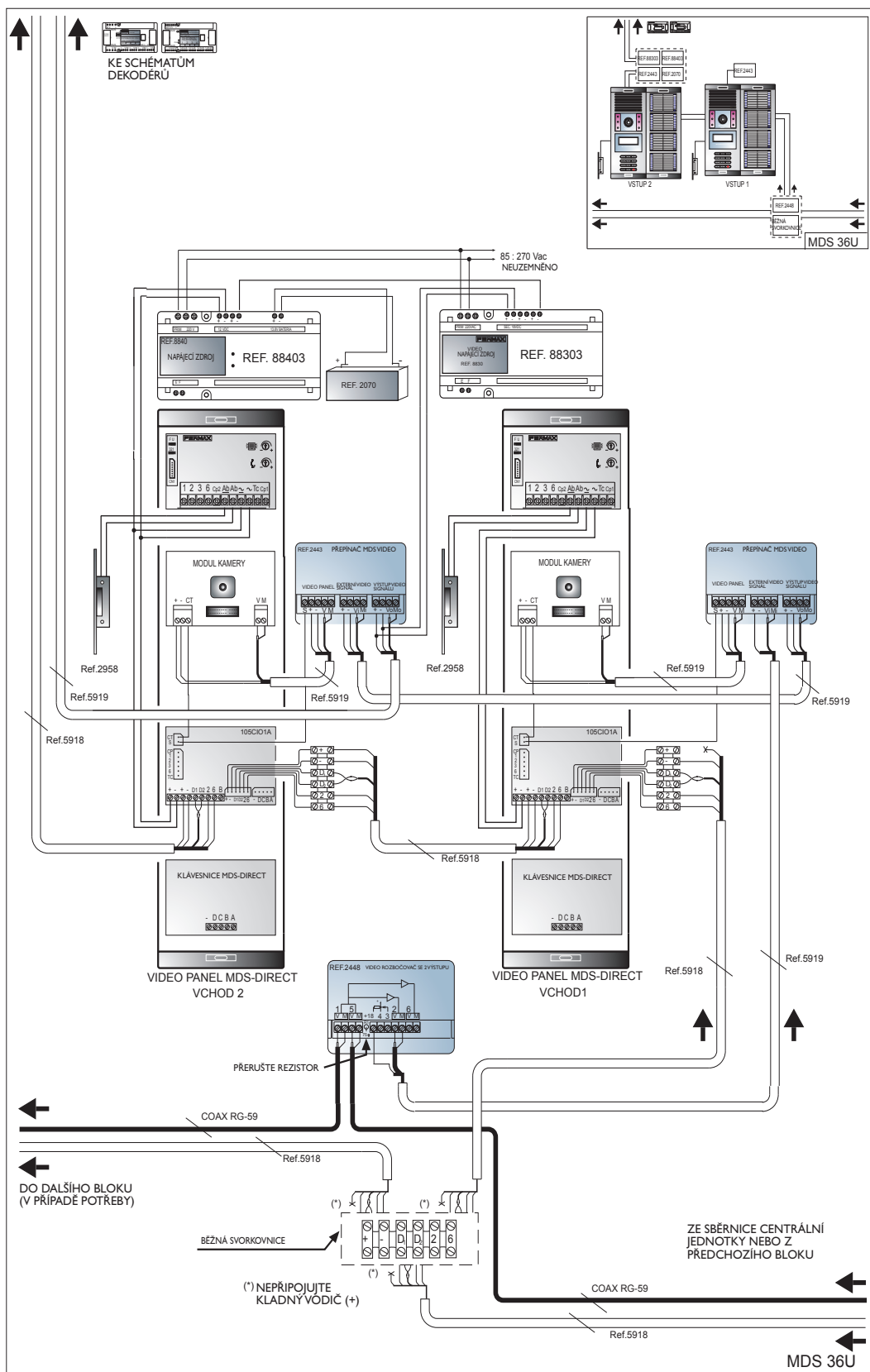

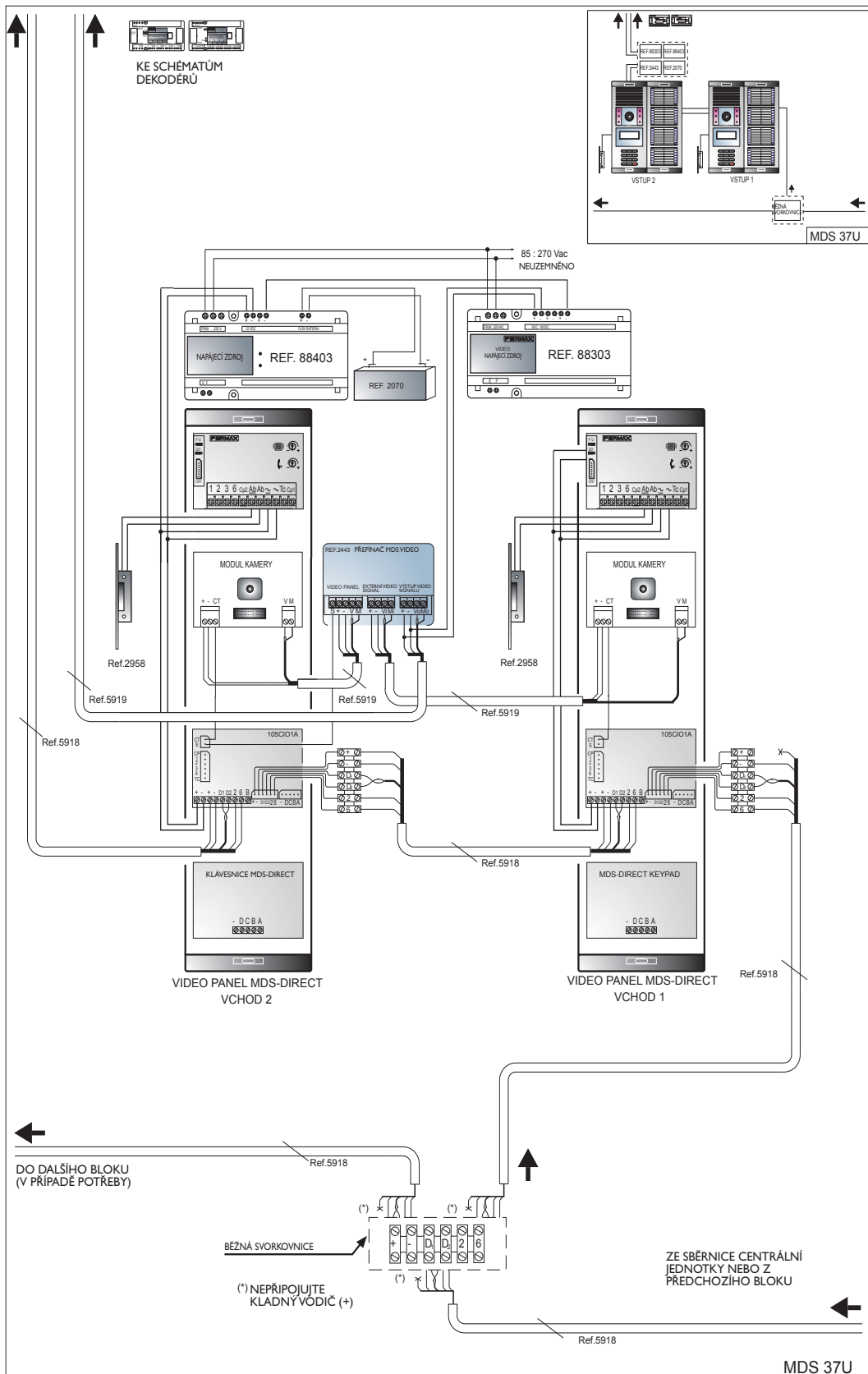

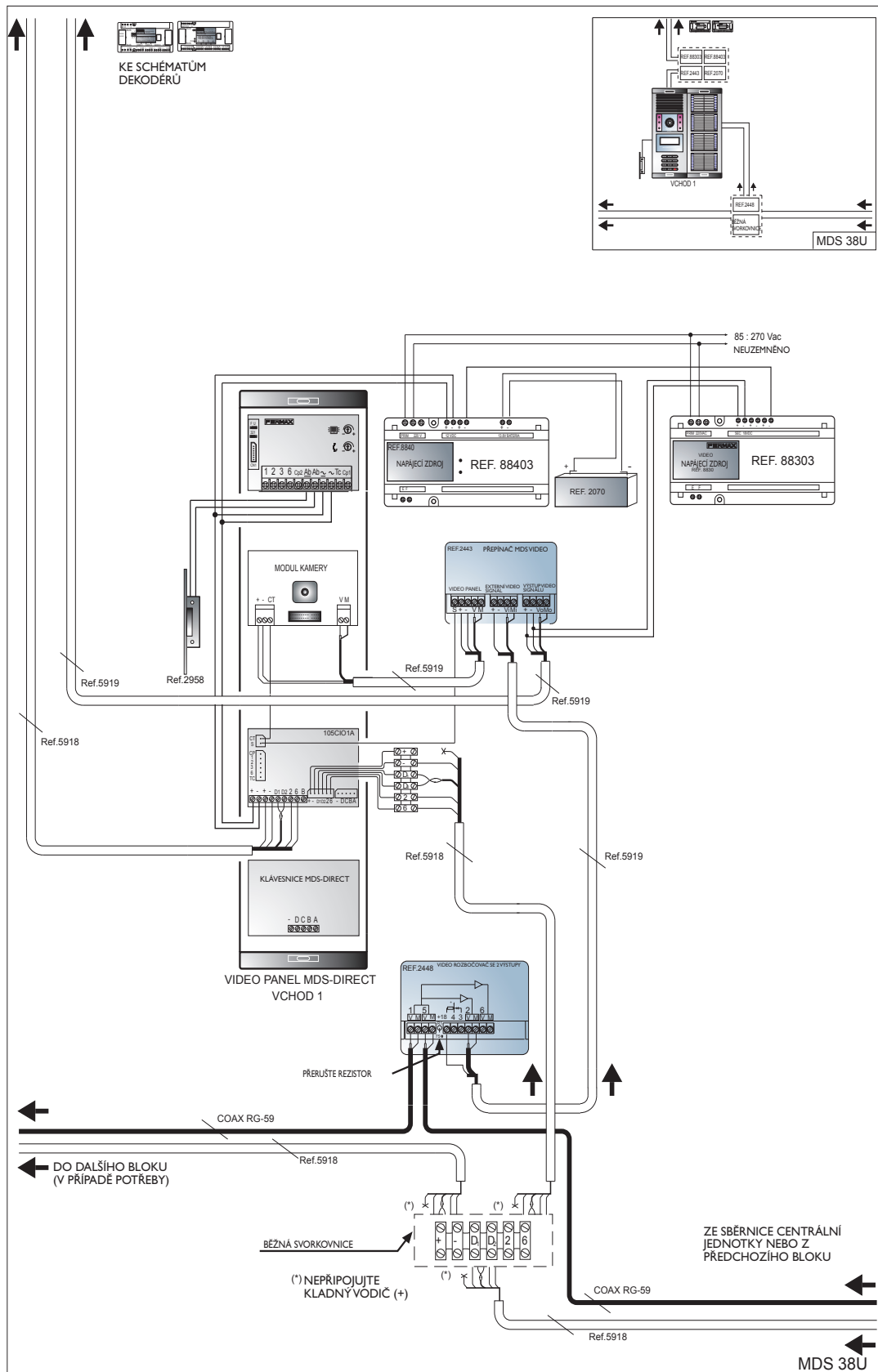

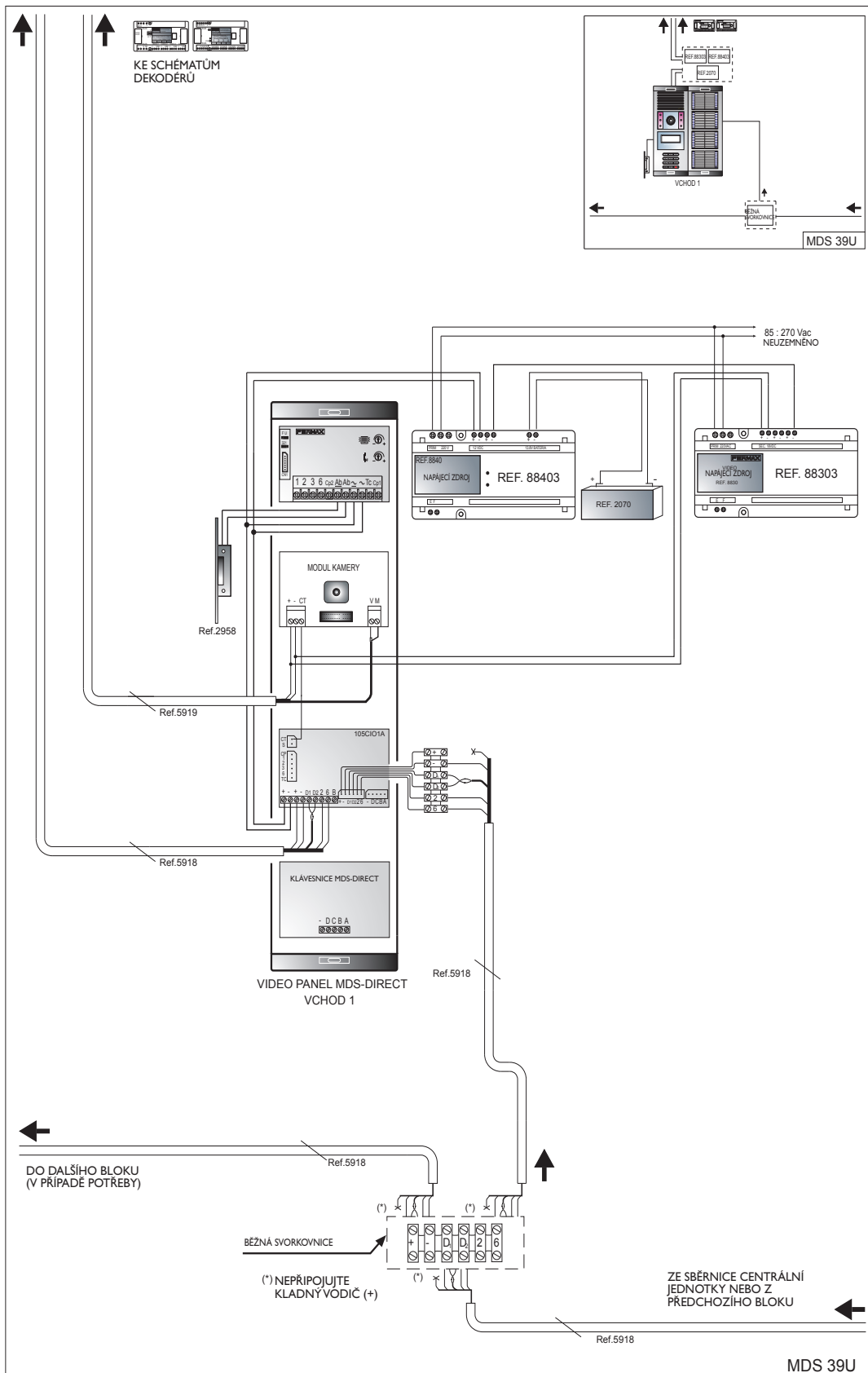

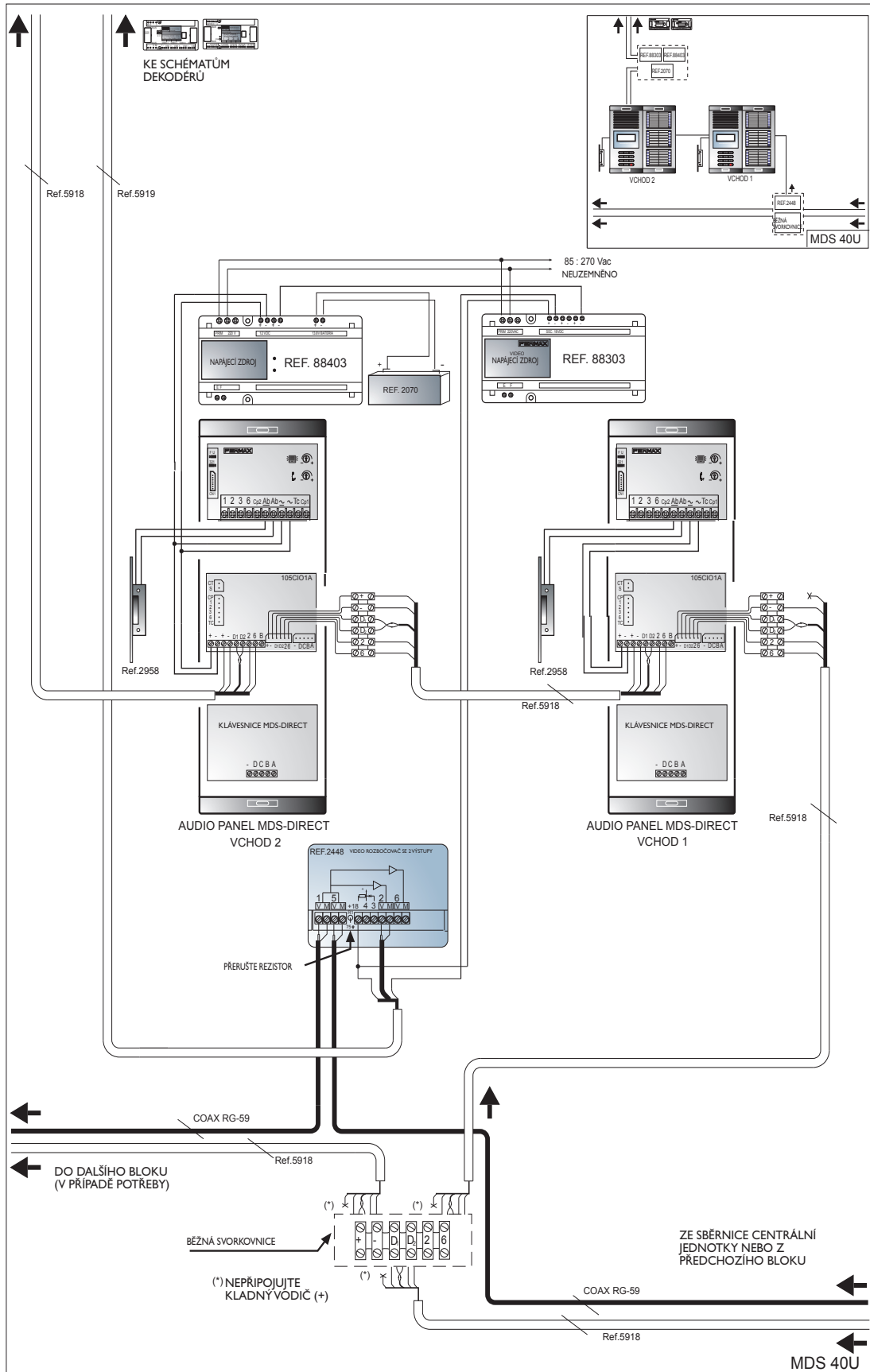

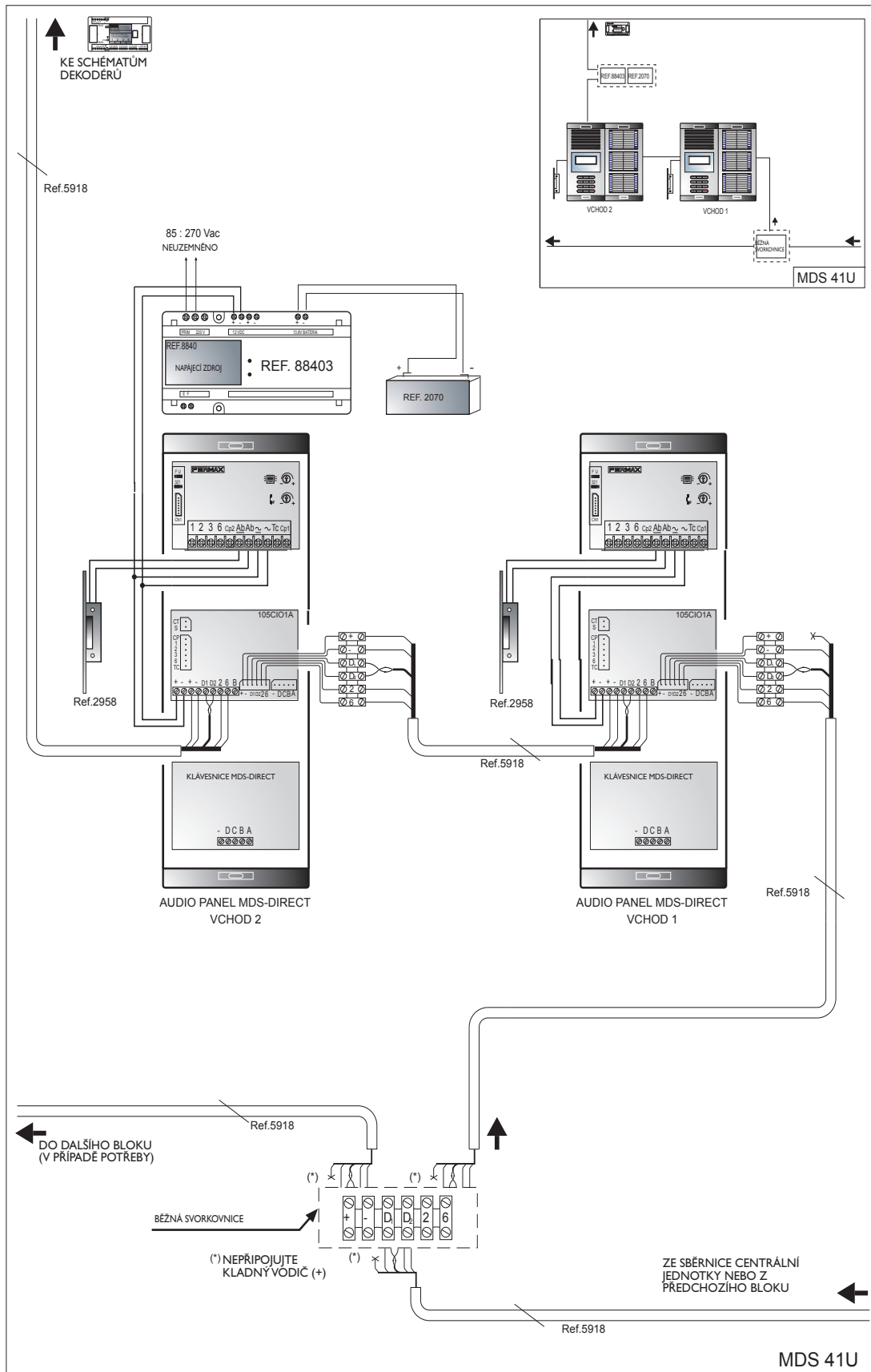

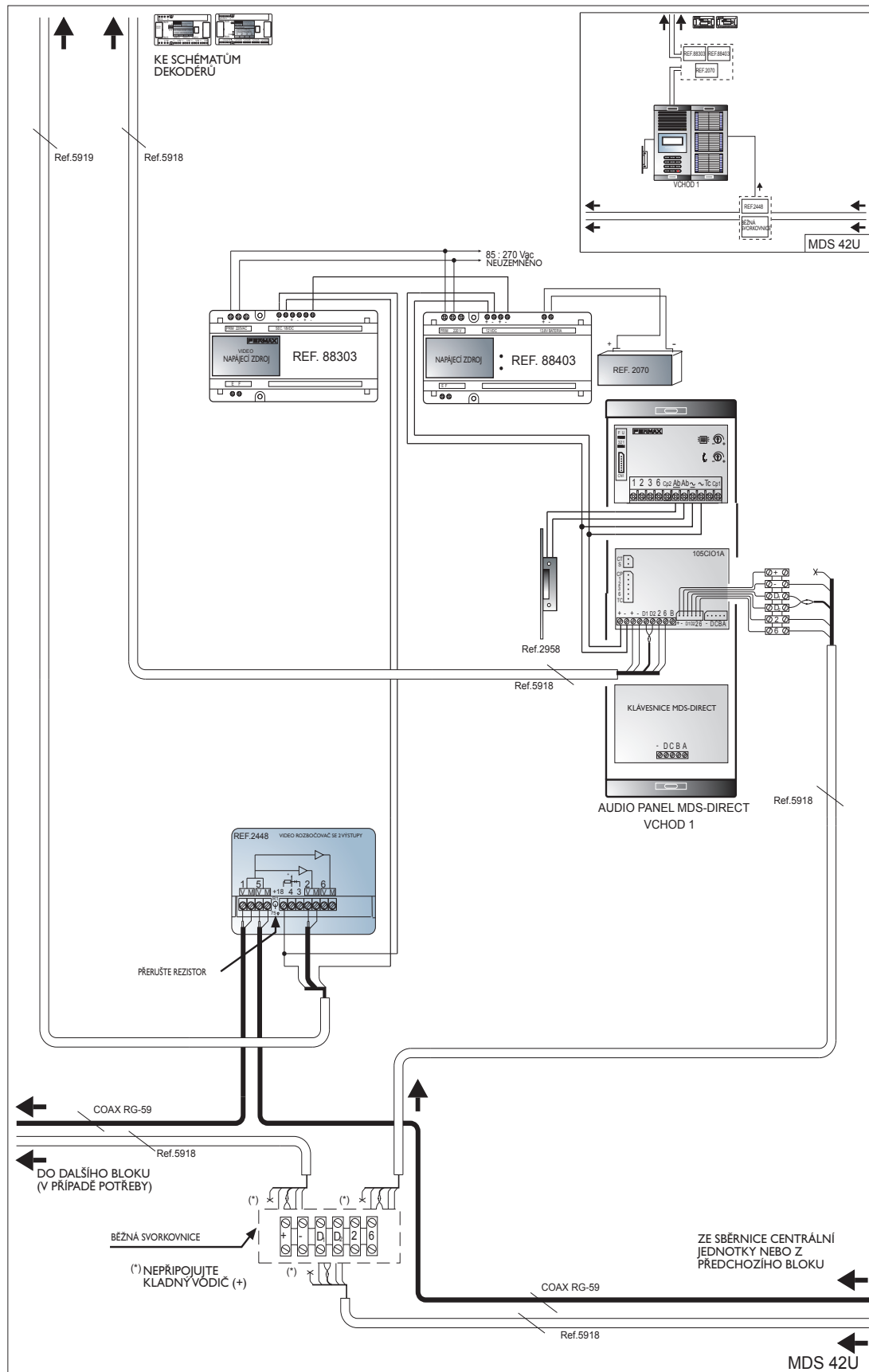

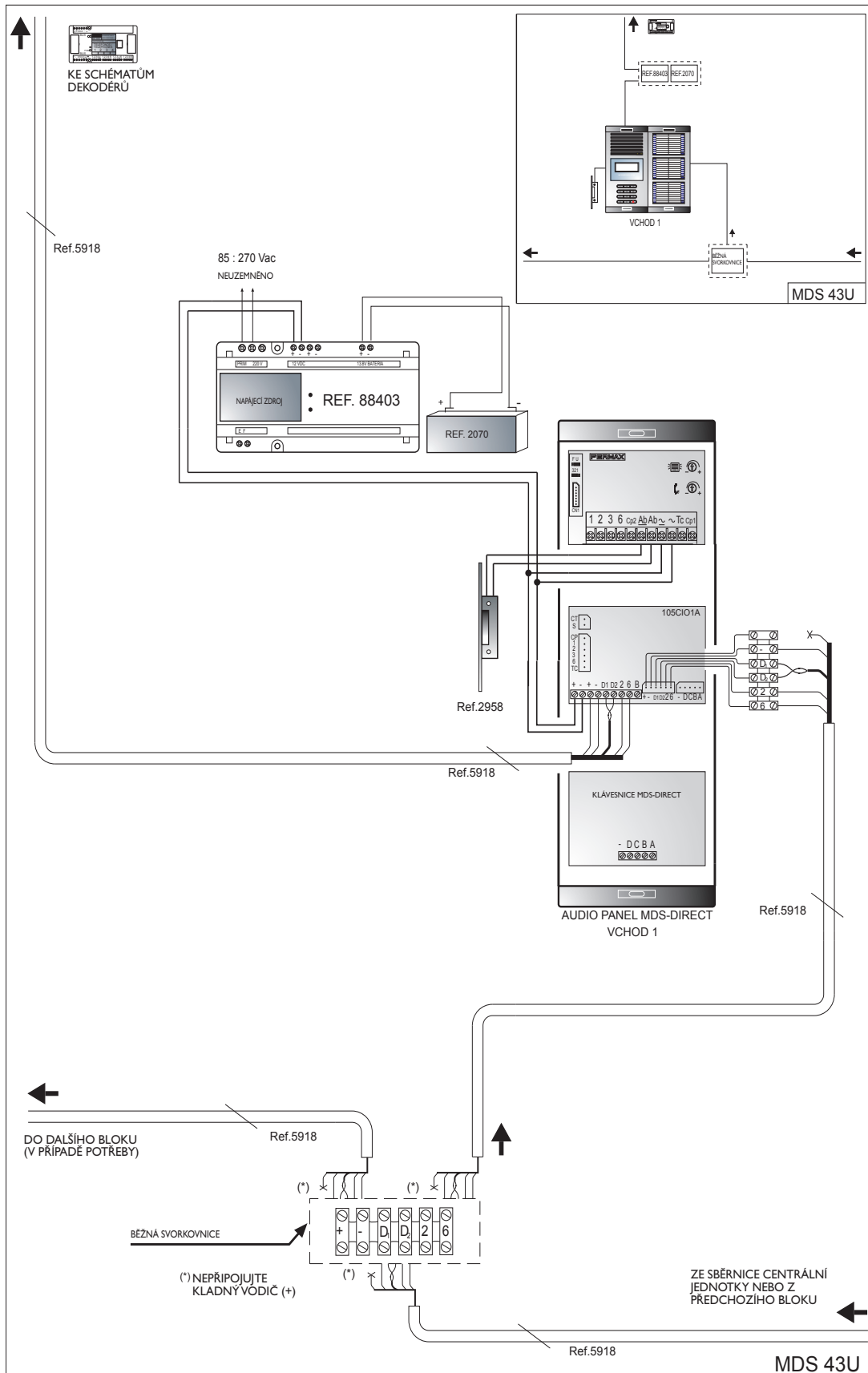

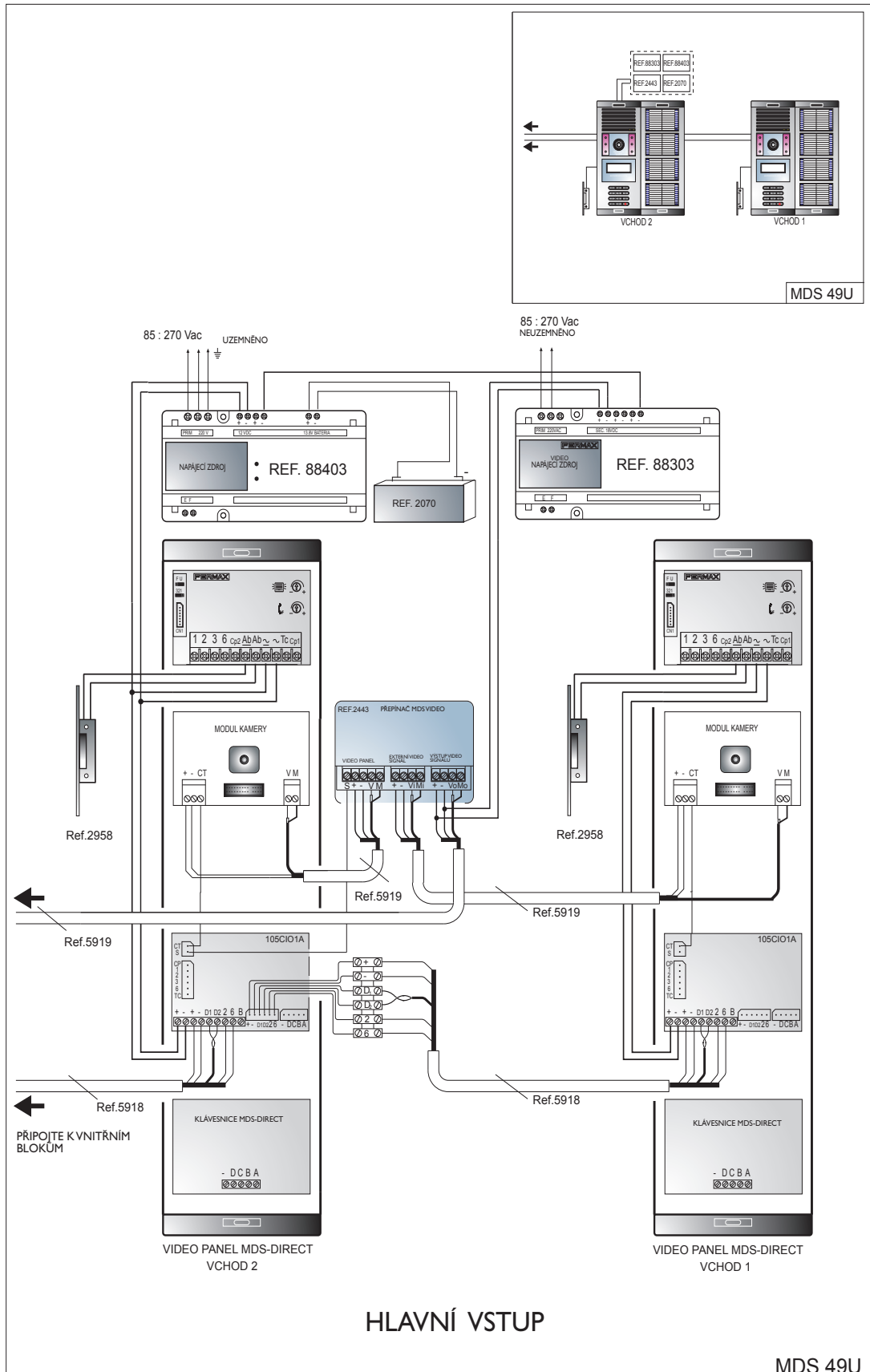

MDS 50U

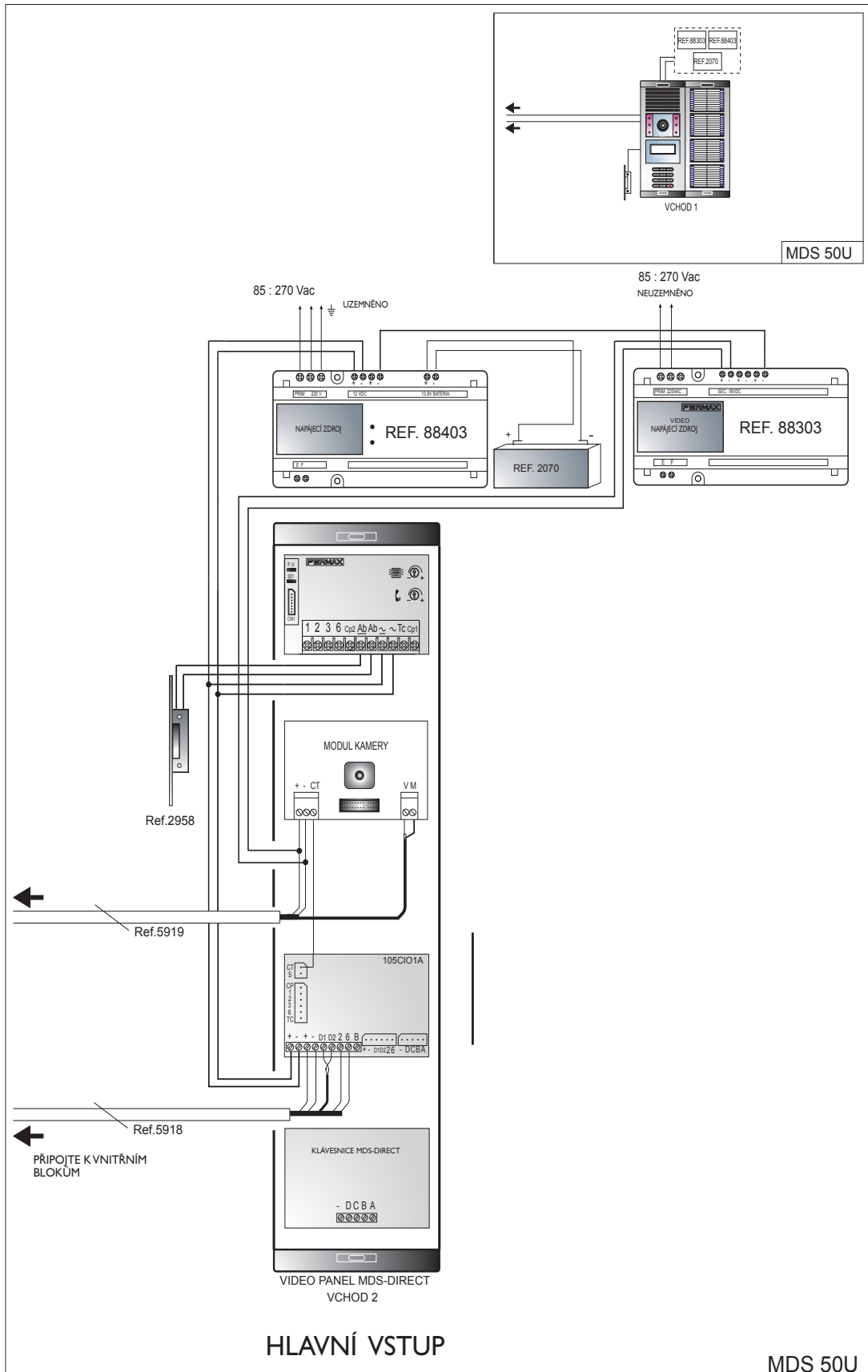

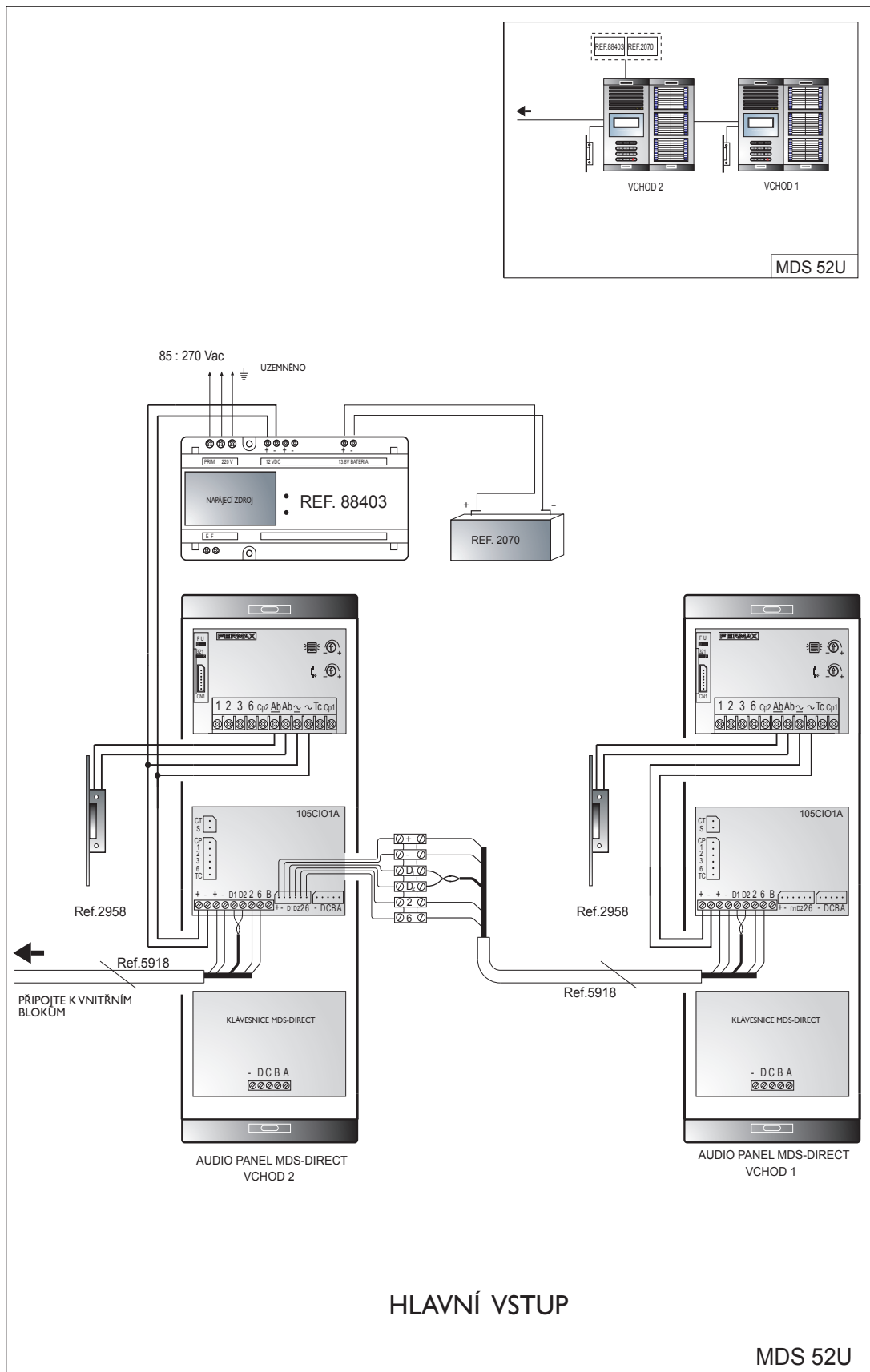

MDS 53U

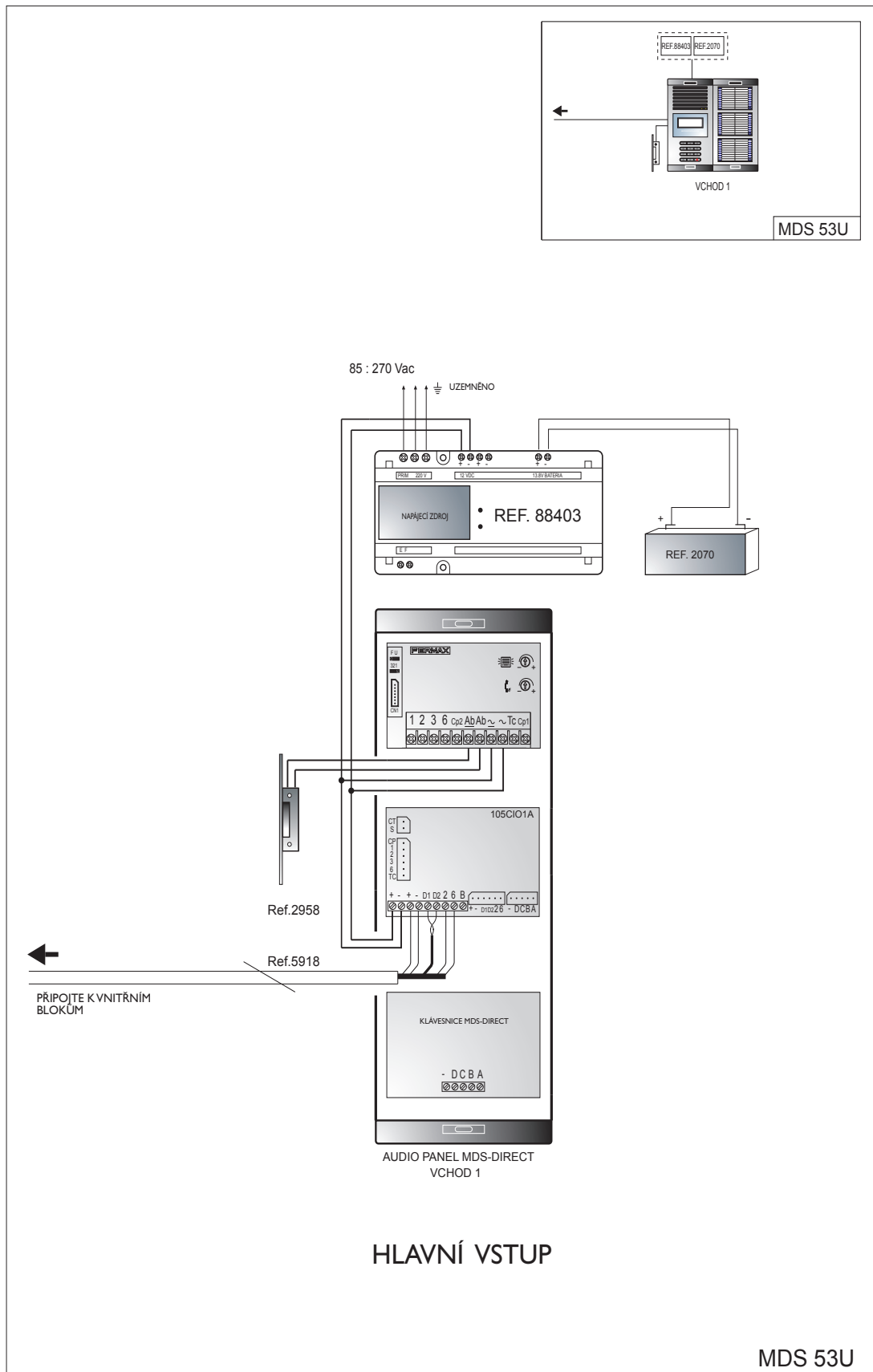

MDS 54A

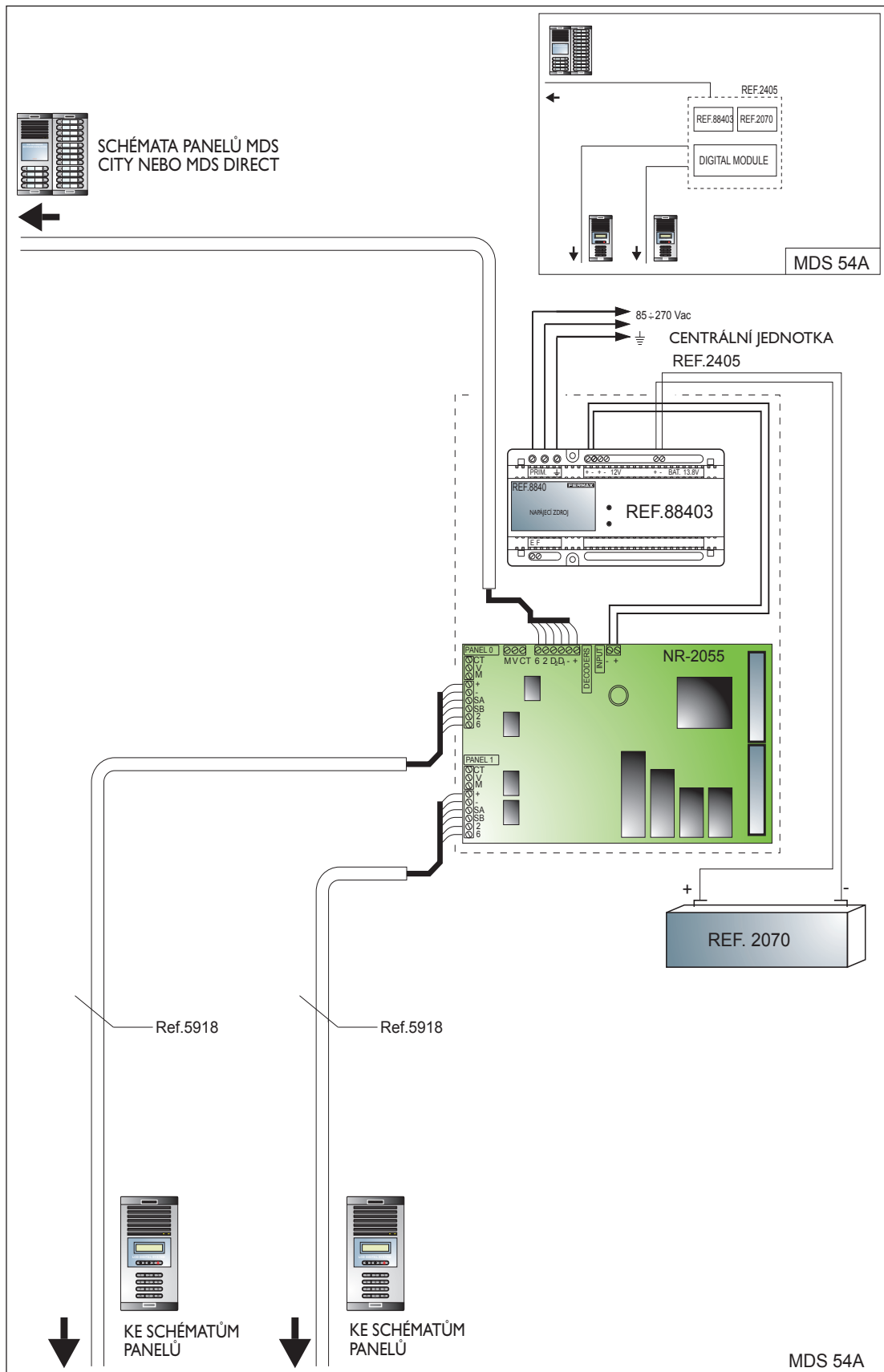

MDS 55A

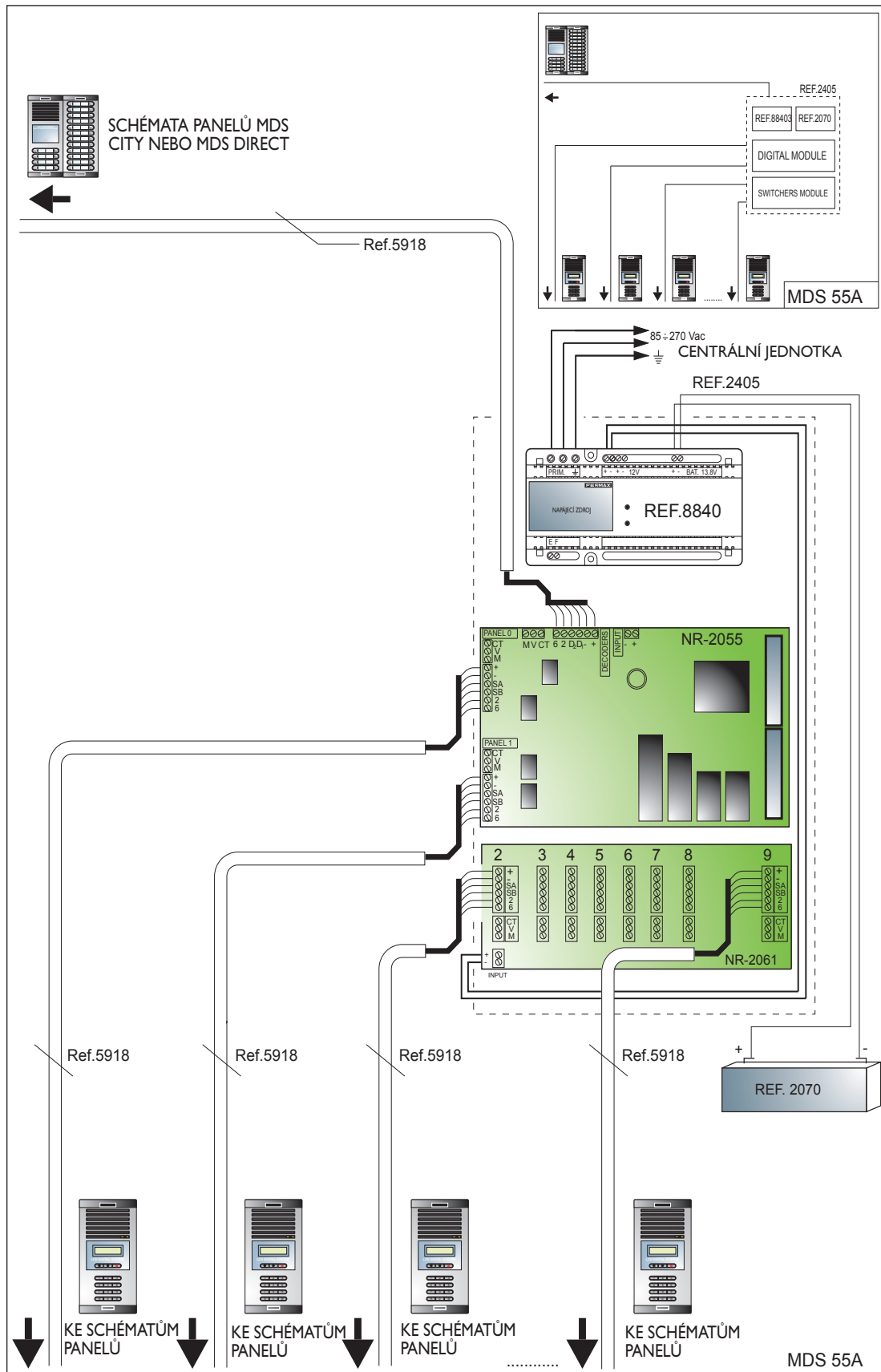

MDS 56A

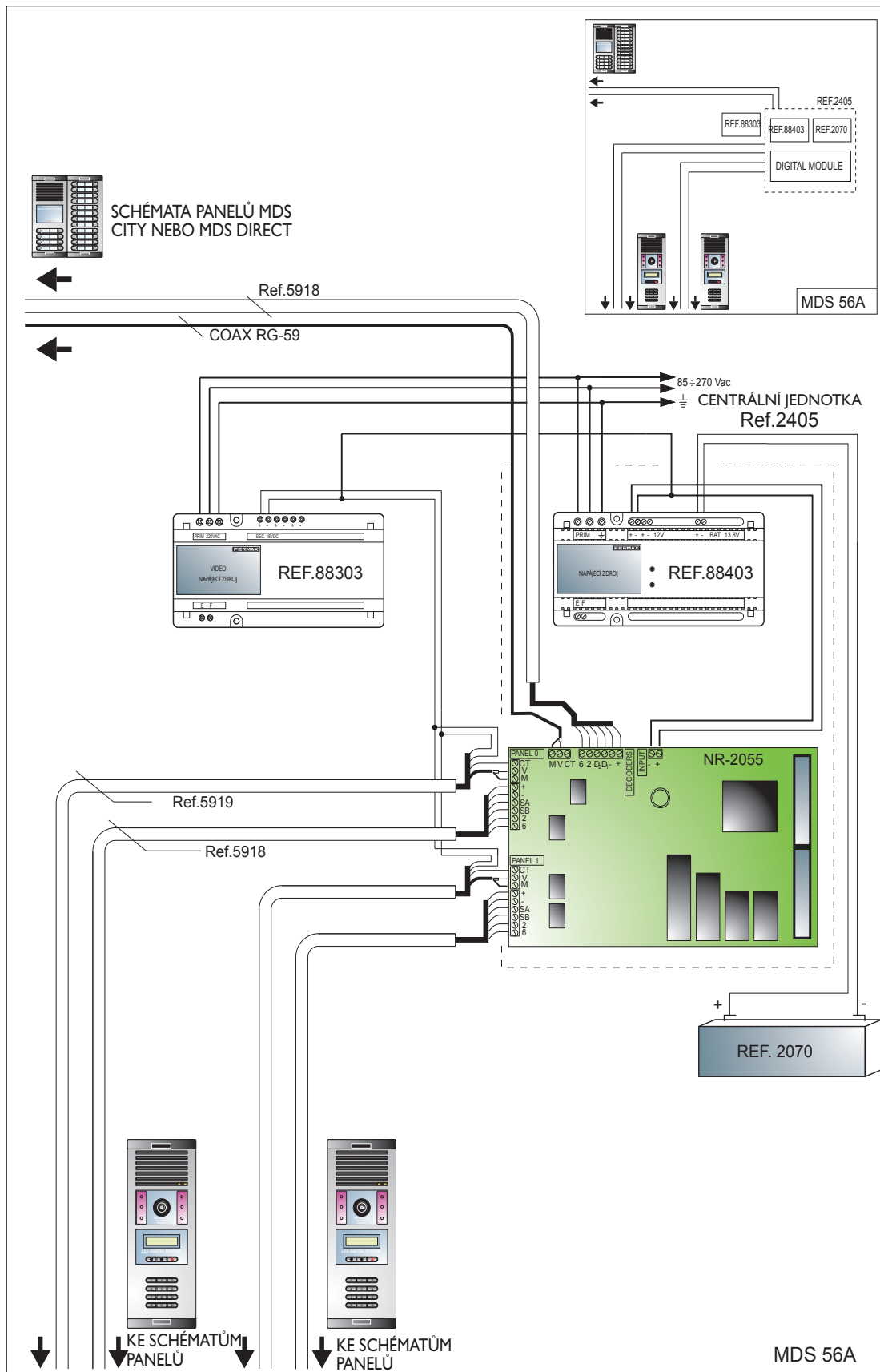

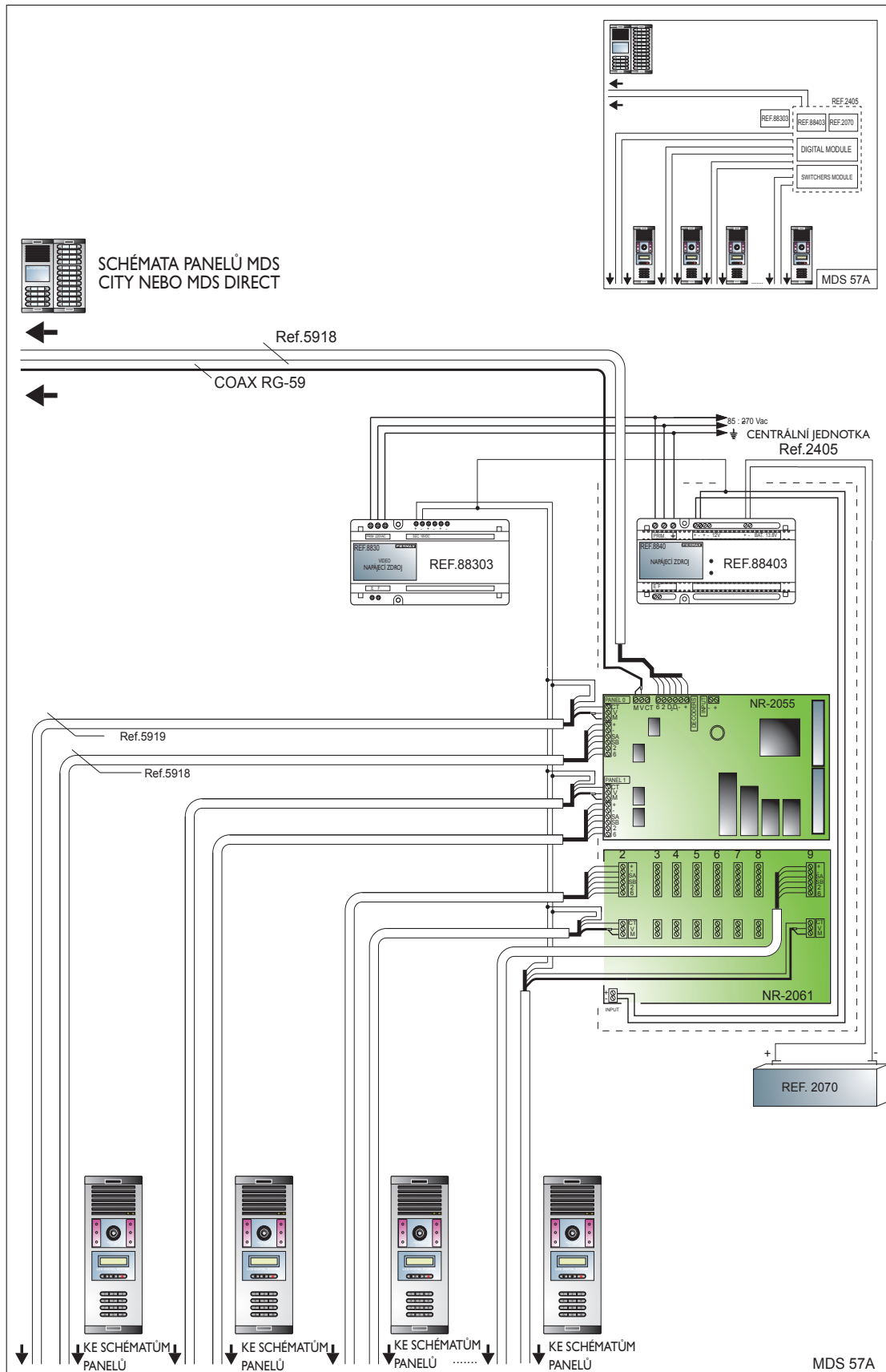

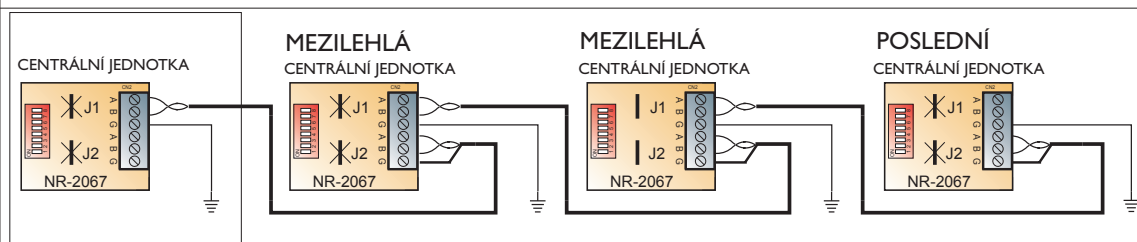
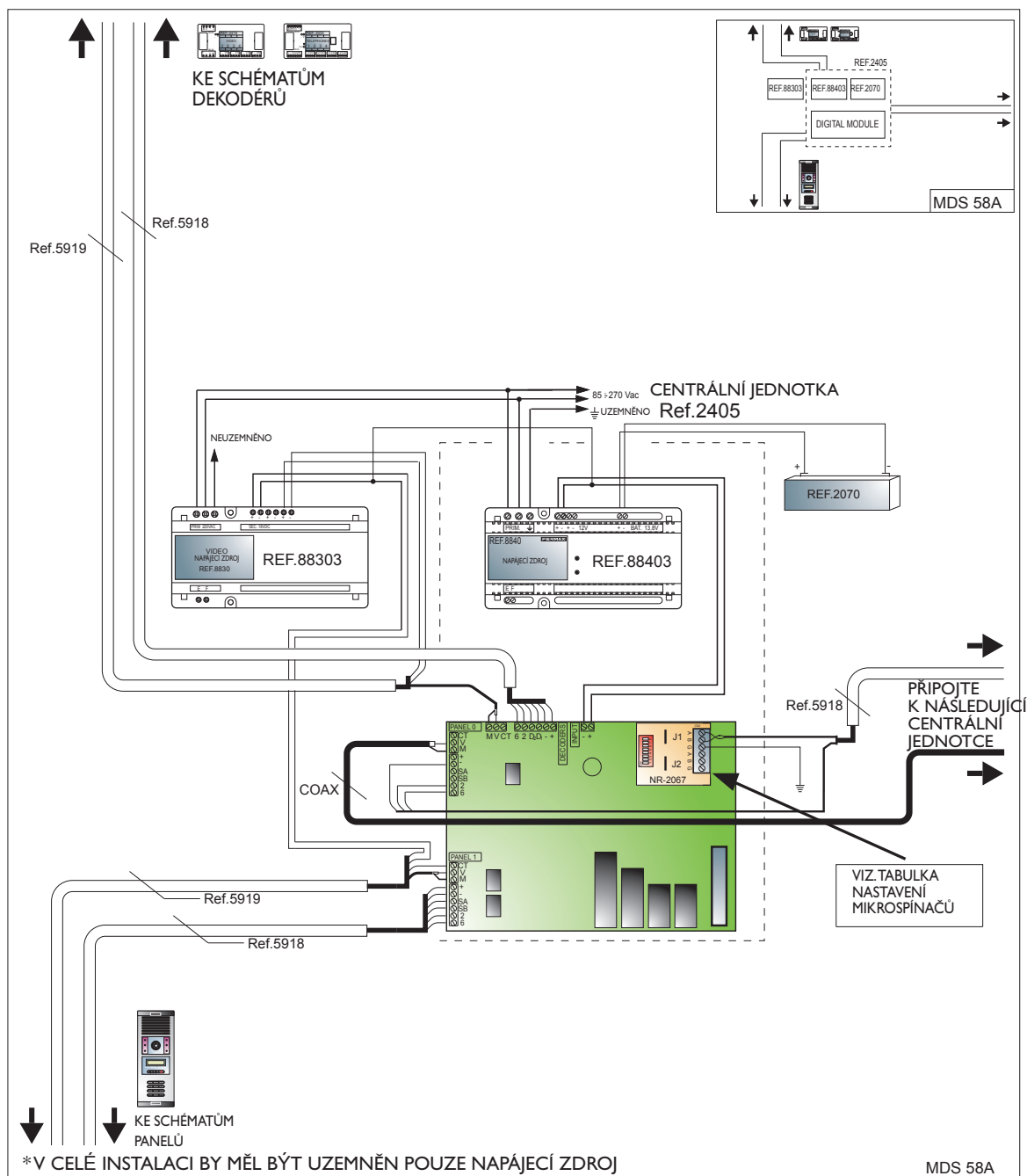

* STÍNĚNÍ KROUCENÉ DVOJLINKY SPOJUJÍCÍ DVĚ CENTRÁLNÍ JEDNOTKY MUSÍ BÝT UZEMNĚN POUZE V JEDNÉ CENTRÁLNÍ JEDNOTCE.

* U VŠECH CENTRÁLNÍCH JEDNOTEK, KROMĚ JEDNÉ Z MEZILEHLÝCH, PŘERUŠTE PROPOJKY J1 A J2.

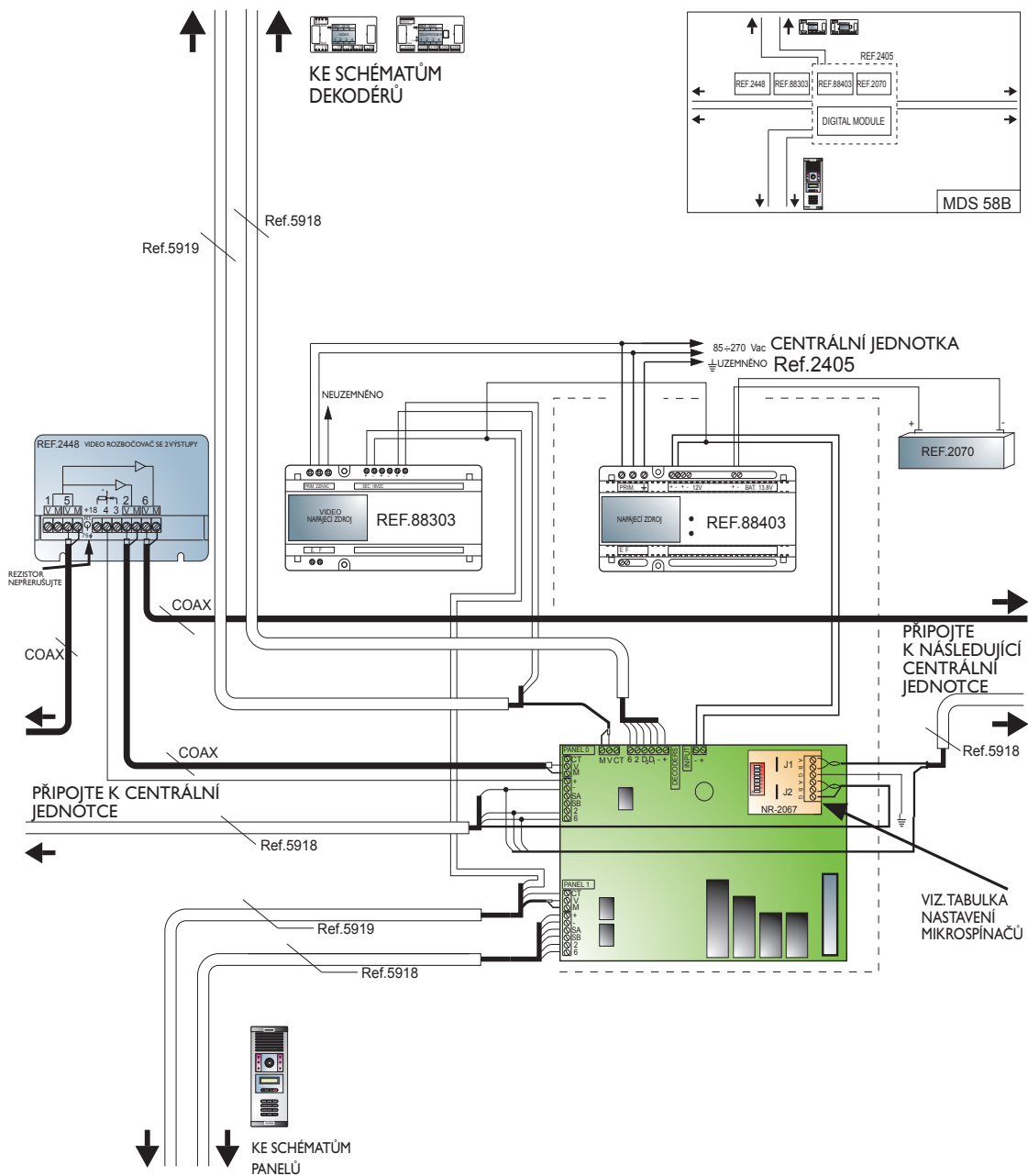

*V CELÉ INSTALACI BY MĚL BÝT UZEMNĚN POUZE NAPÁJECÍ ZDROJ

MDS 58B

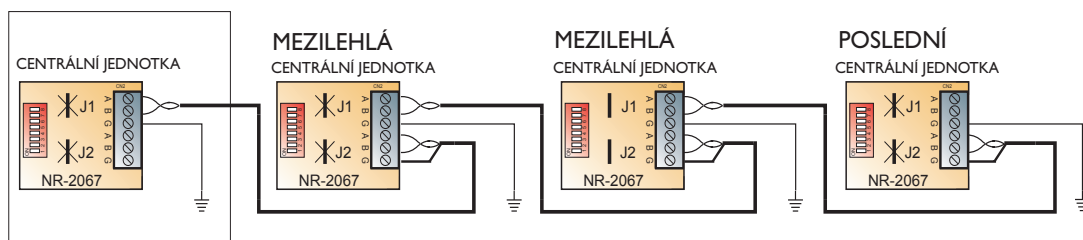

* STÍNĚNÍ KROUCENÉ DVOJLINKY SPOJUJÍCÍ DVĚ CENTRÁLNÍ JEDNOTKY MUSÍ BÝT UZEMNĚN POUZE V JEDNÉ CENTRÁLNÍ JEDNOTCE.

* U VŠECH CENTRÁLNÍCH JEDNOTEK, KROMĚ JEDNÉ Z MEZILEHLÝCH, PŘERUŠTE PROPOJKY J1 A J2.

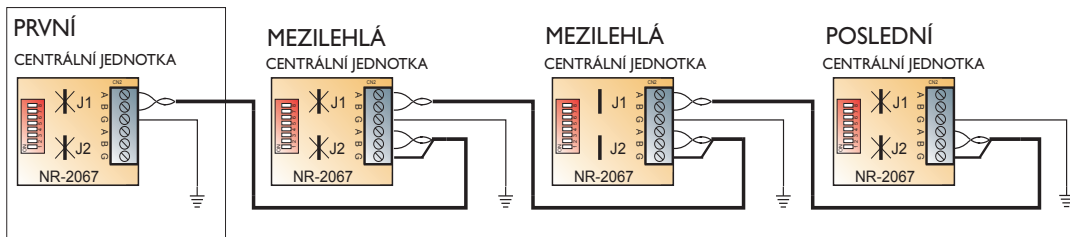
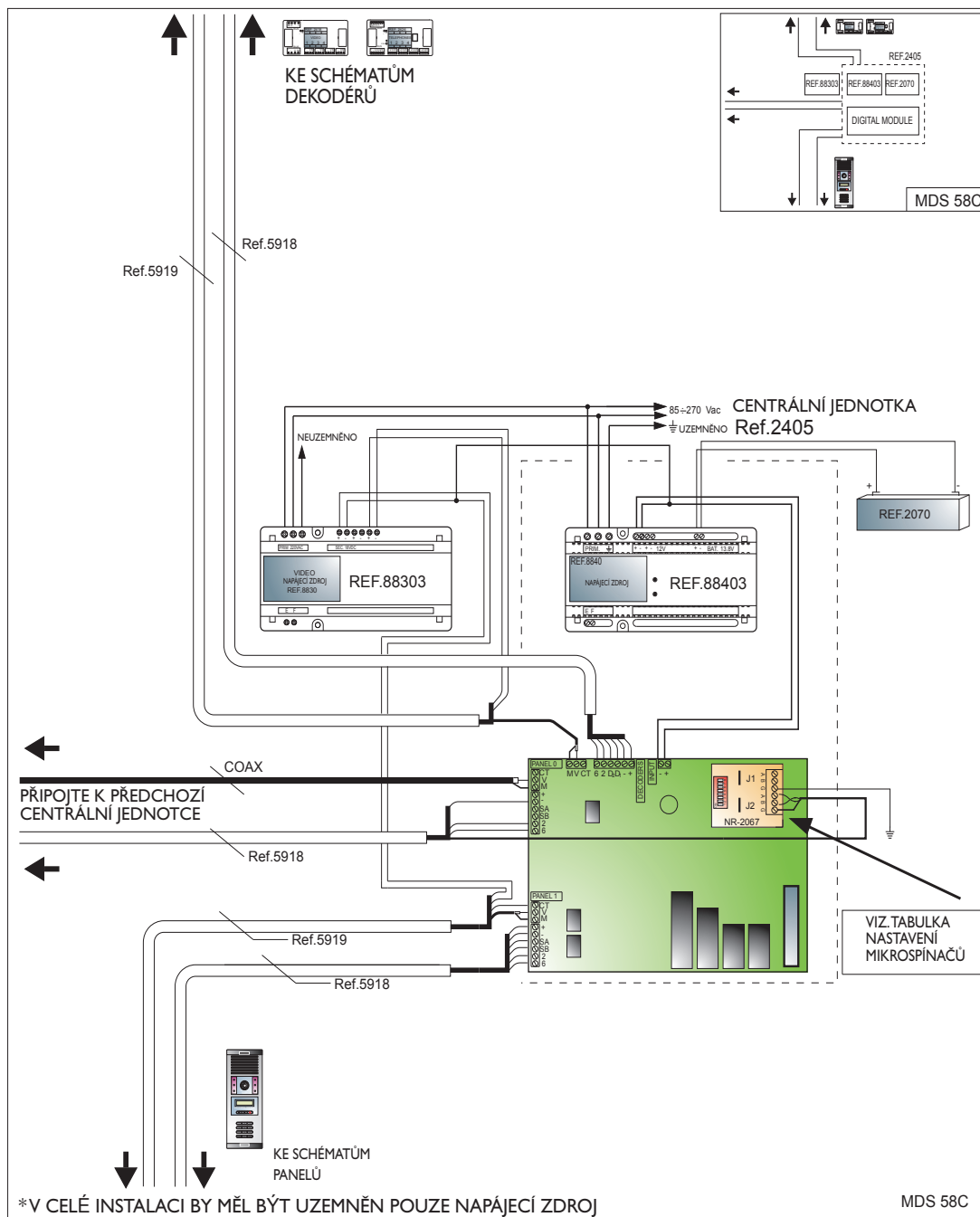

* STÍNĚNÍ KROUCENÉ DVOJLINKY SPOJUJÍCÍ DVĚ CENTRÁLNÍ JEDNOTKY MUSÍ BÝT UZEMNĚN POUZE V JEDNÉ CENTRÁLNÍ JEDNOTCE.

* U VŠECH CENTRÁLNÍCH JEDNOTEK, KROMĚ JEDNÉ Z MEZILEHLÝCH, PŘERUŠTE PROPOJKY J1 A J2.

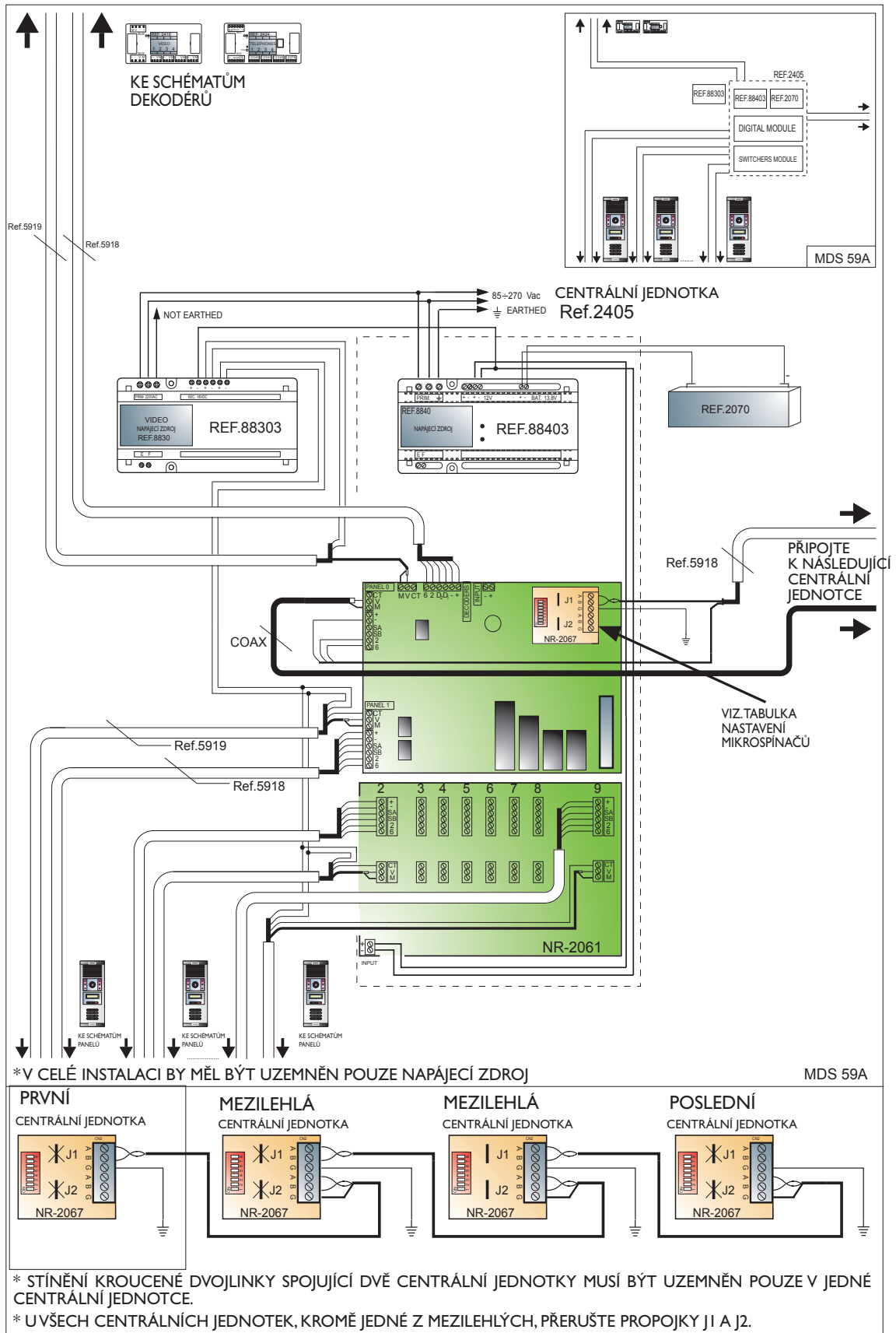

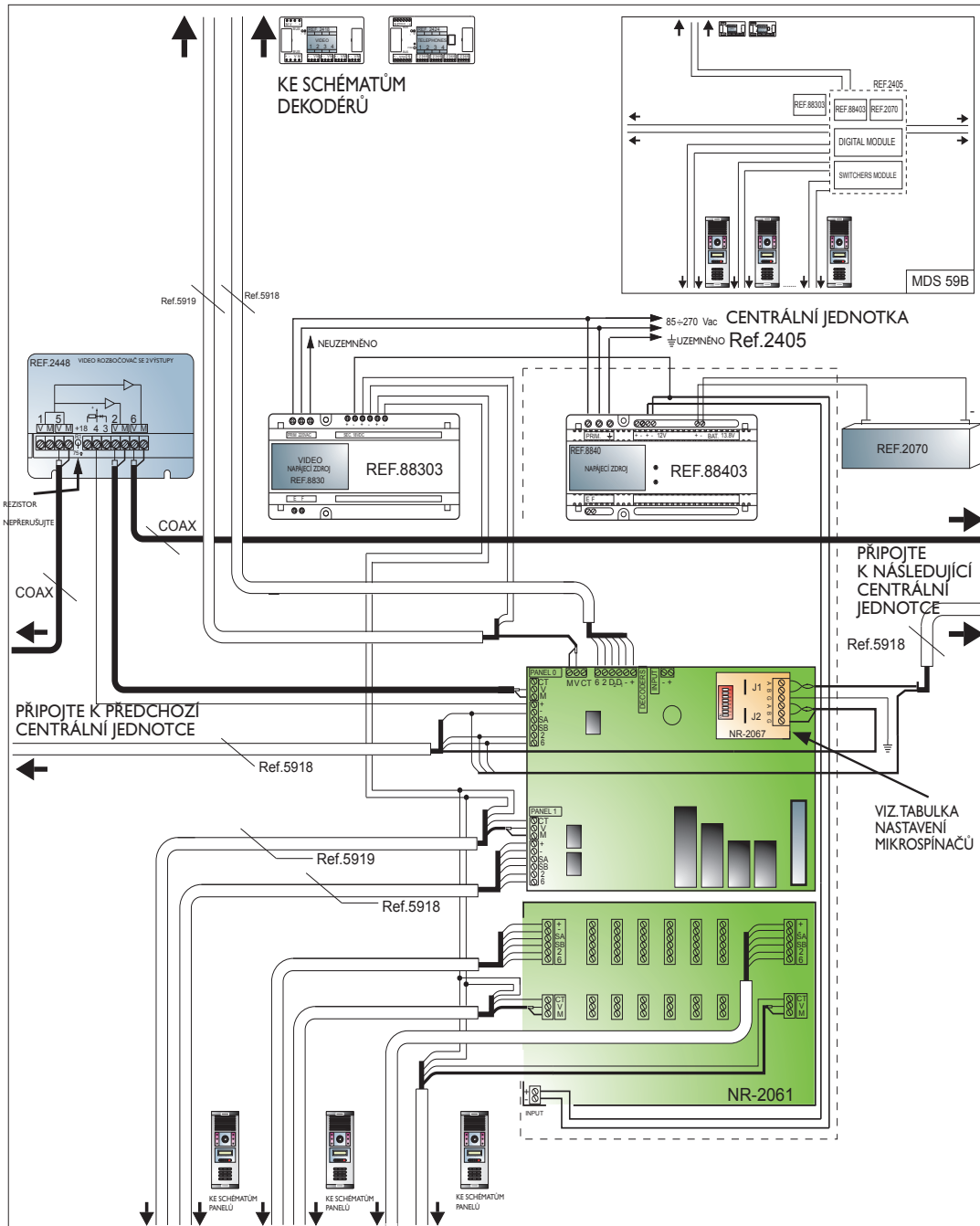

*V CELÉ INSTALACI BY MĚL BÝT UZEMNĚN POUZE NAPÁJECÍ ZDROJ

MDS 59B

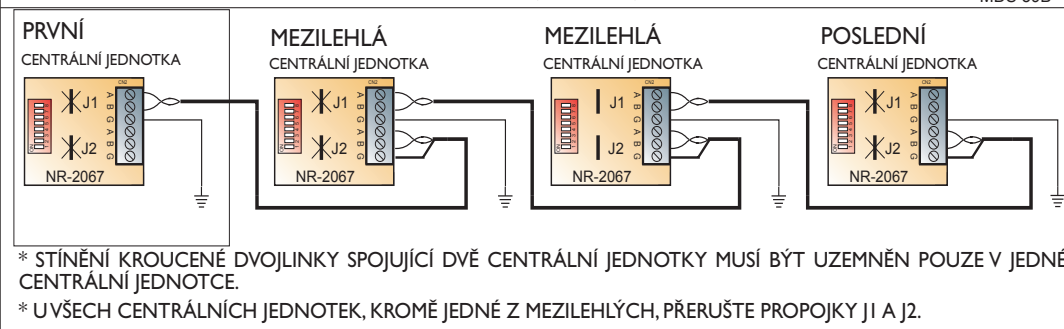

MDS 64A

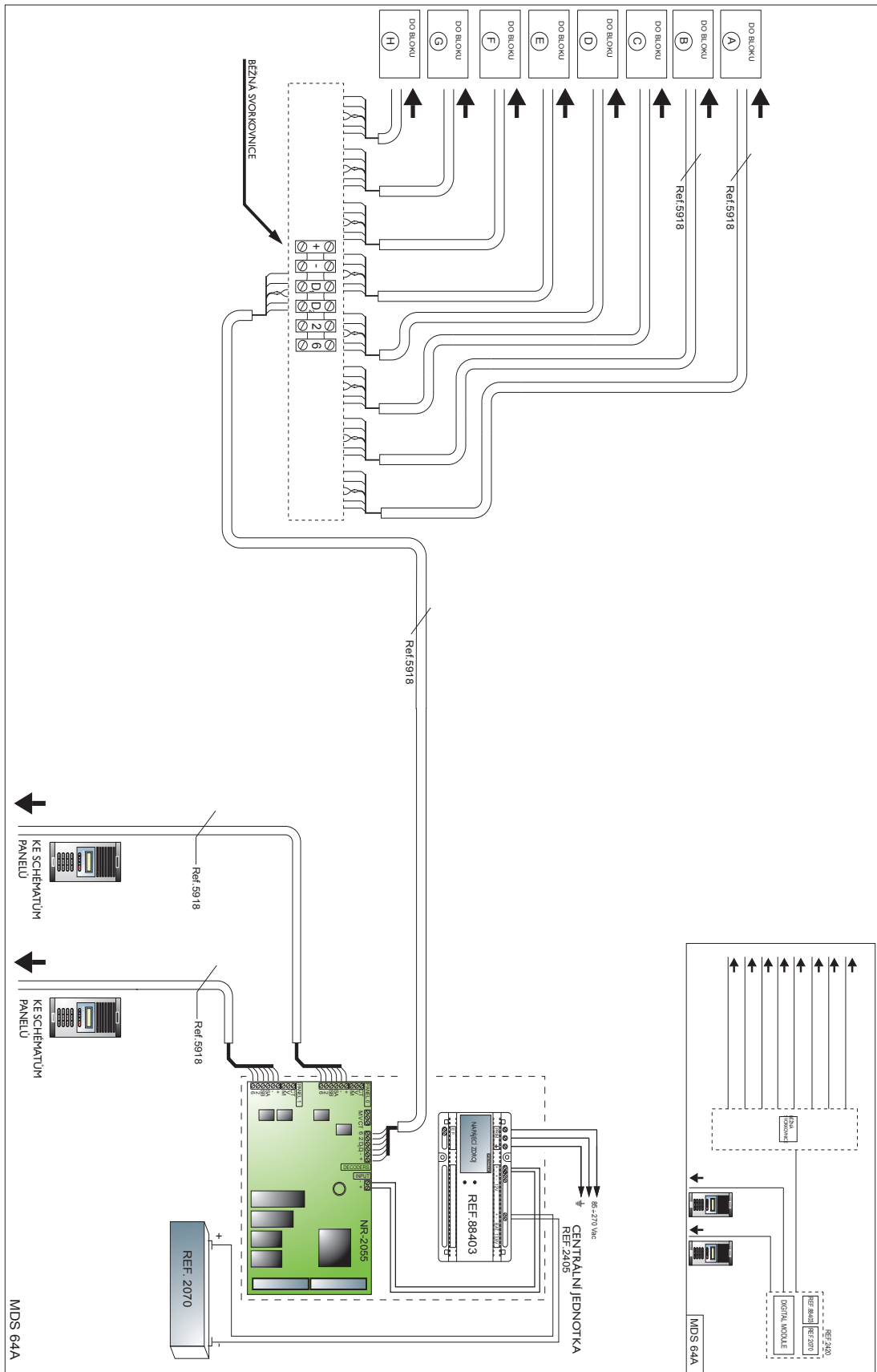

MDS 64A

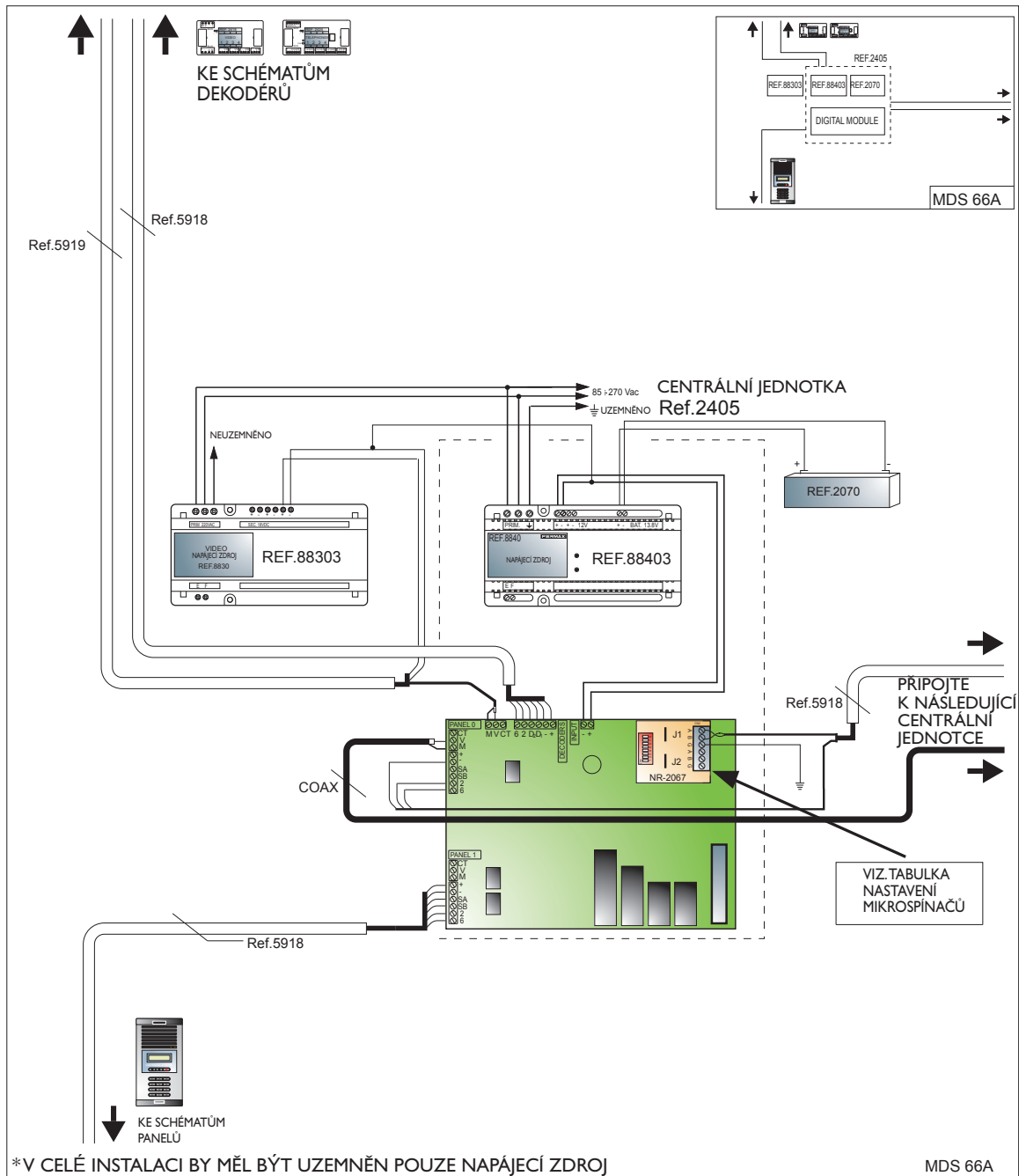

PRVNÍ
CENTRÁLNÍ JEDNOTKA

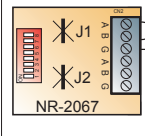

MEZILEHLÁ
CENTRÁLNÍ JEDNOTKA

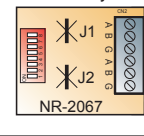

MEZILEHLÁ
CENTRÁLNÍ JEDNOTKA

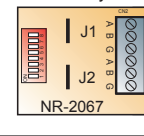

POSLEDNÍ
CENTRÁLNÍ JEDNOTKA

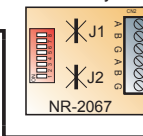

* STÍNĚNÍ KROUČENÉ DVOJLINKY SPOJUJÍCÍ DVĚ CENTRÁLNÍ JEDNOTKY MUSÍ BÝT UZEMNĚN POUZE V JEDNÉ CENTRÁLNÍ JEDNOTCE.

* U VŠECH CENTRÁLNÍCH JEDNOTEK, KROMĚ JEDNÉ Z MEZILEHLÝCH, PŘERUŠTE PROPOJKY J1 A J2.

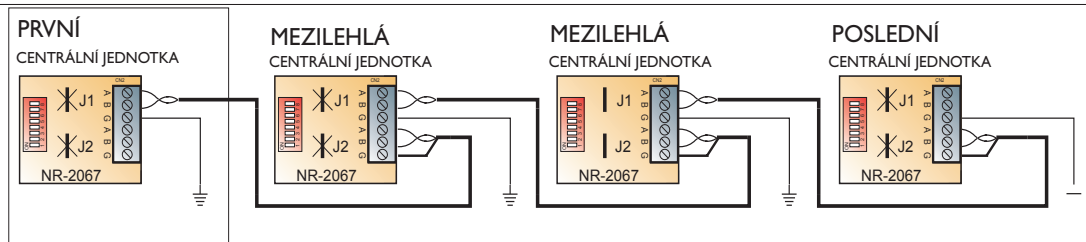
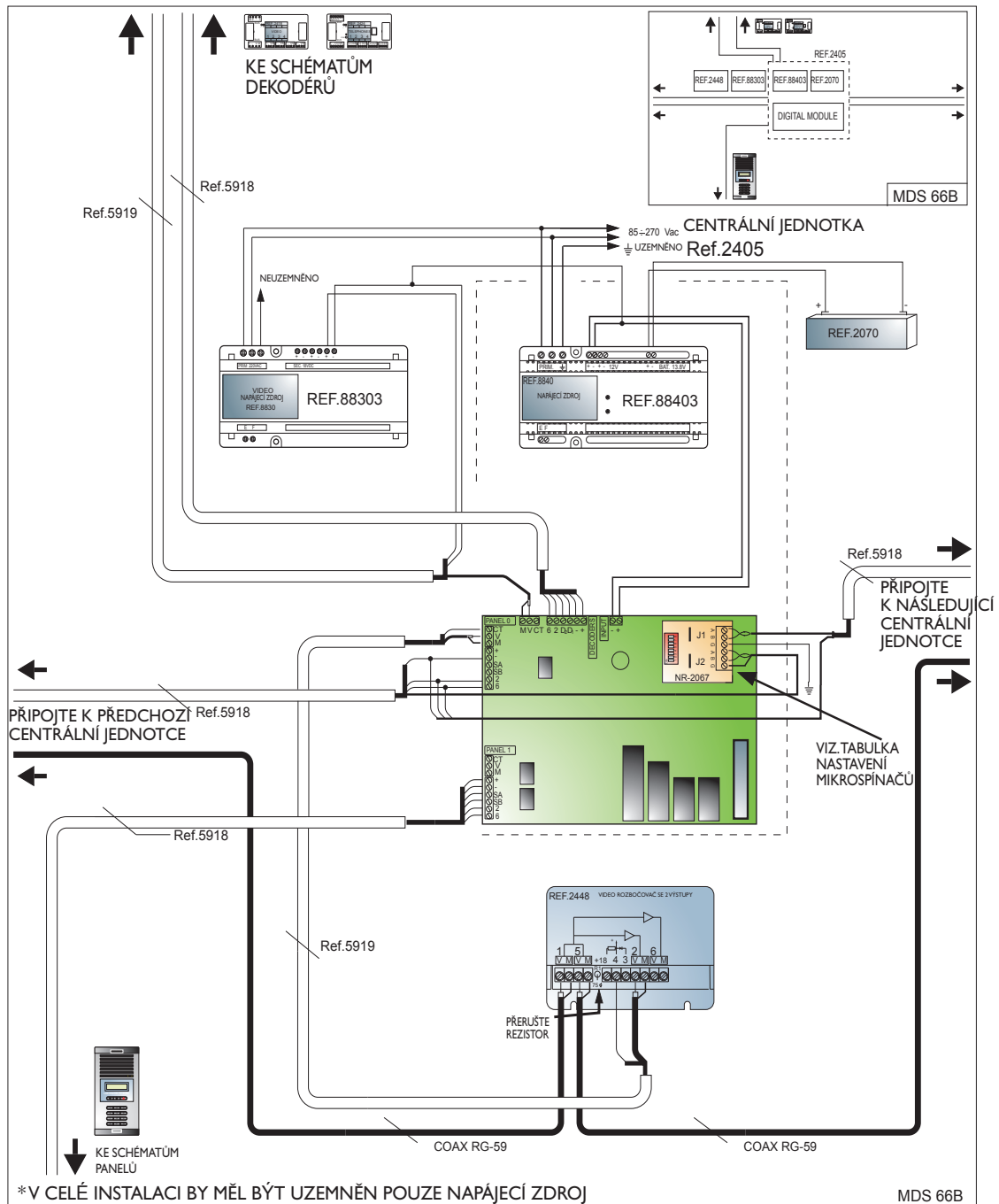

* STÍNĚNÍ KROUČENÉ DVOJLINKY SPOJUJÍCÍ DVĚ CENTRÁLNÍ JEDNOTKY MUSÍ BÝT UZEMNĚN POUZE V JEDNÉ CENTRÁLNÍ JEDNOTCE.

* U VŠECH CENTRÁLNÍCH JEDNOTEK, KROMĚ JEDNÉ Z MEZILEHLÝCH, PŘERUŠTE PROPOJKY J1 A J2.

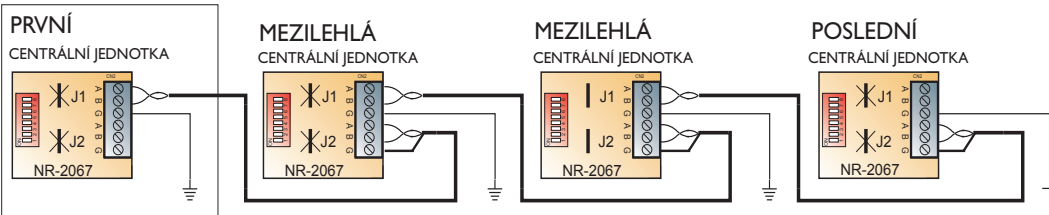
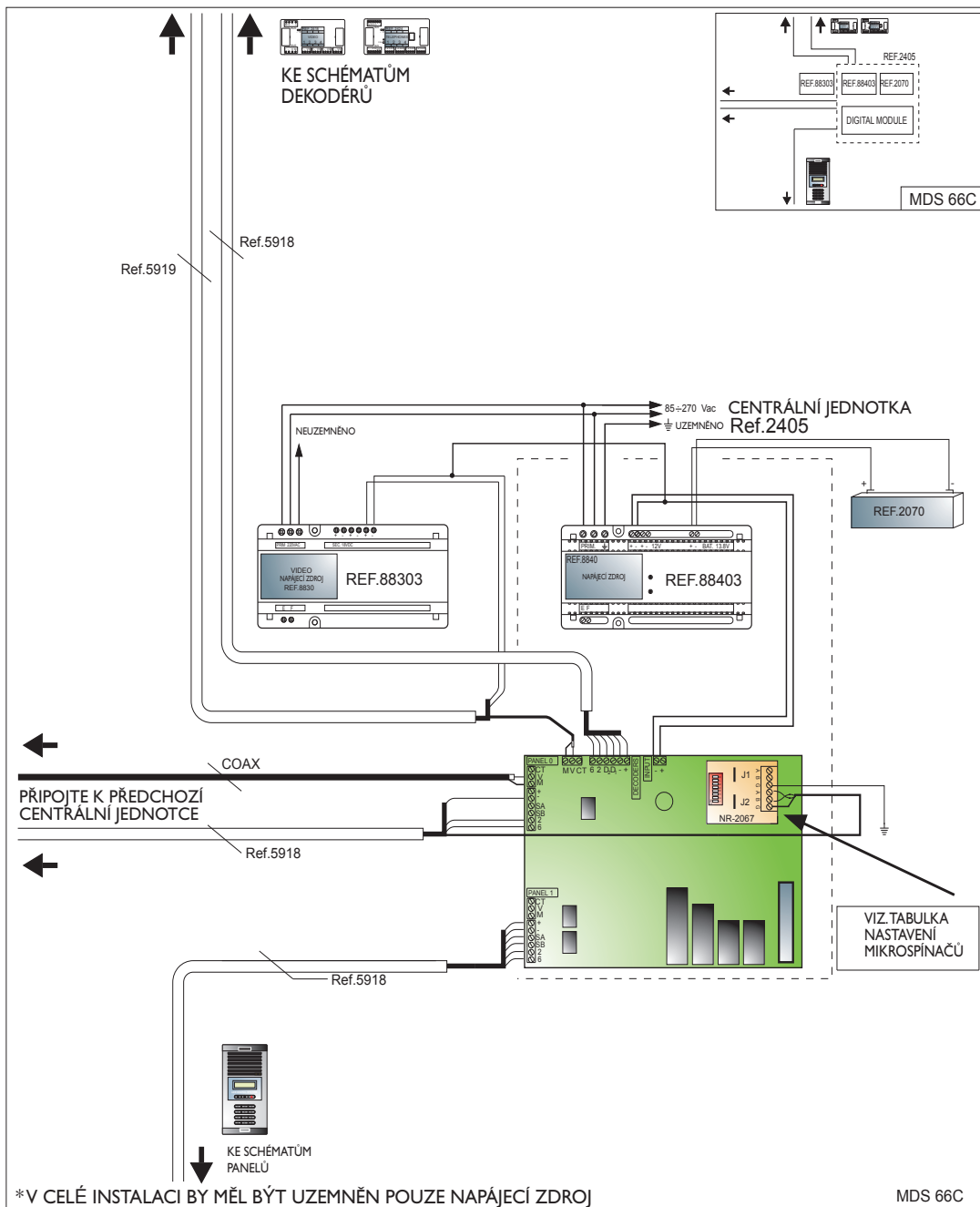

* STÍNĚNÍ KROUČENÉ DVOJLINKY SPOJJÍCÍ DVĚ CENTRÁLNÍ JEDNOTKY MUSÍ BÝT UZEMNĚN POUZE V JEDNÉ CENTRÁLNÍ JEDNOTCE.

* U VŠECH CENTRÁLNÍCH JEDNOTEK, KROMĚ JEDNÉ Z MEZILEHLÝCH, PŘERUŠTE PROPOJKY J1 A J2.

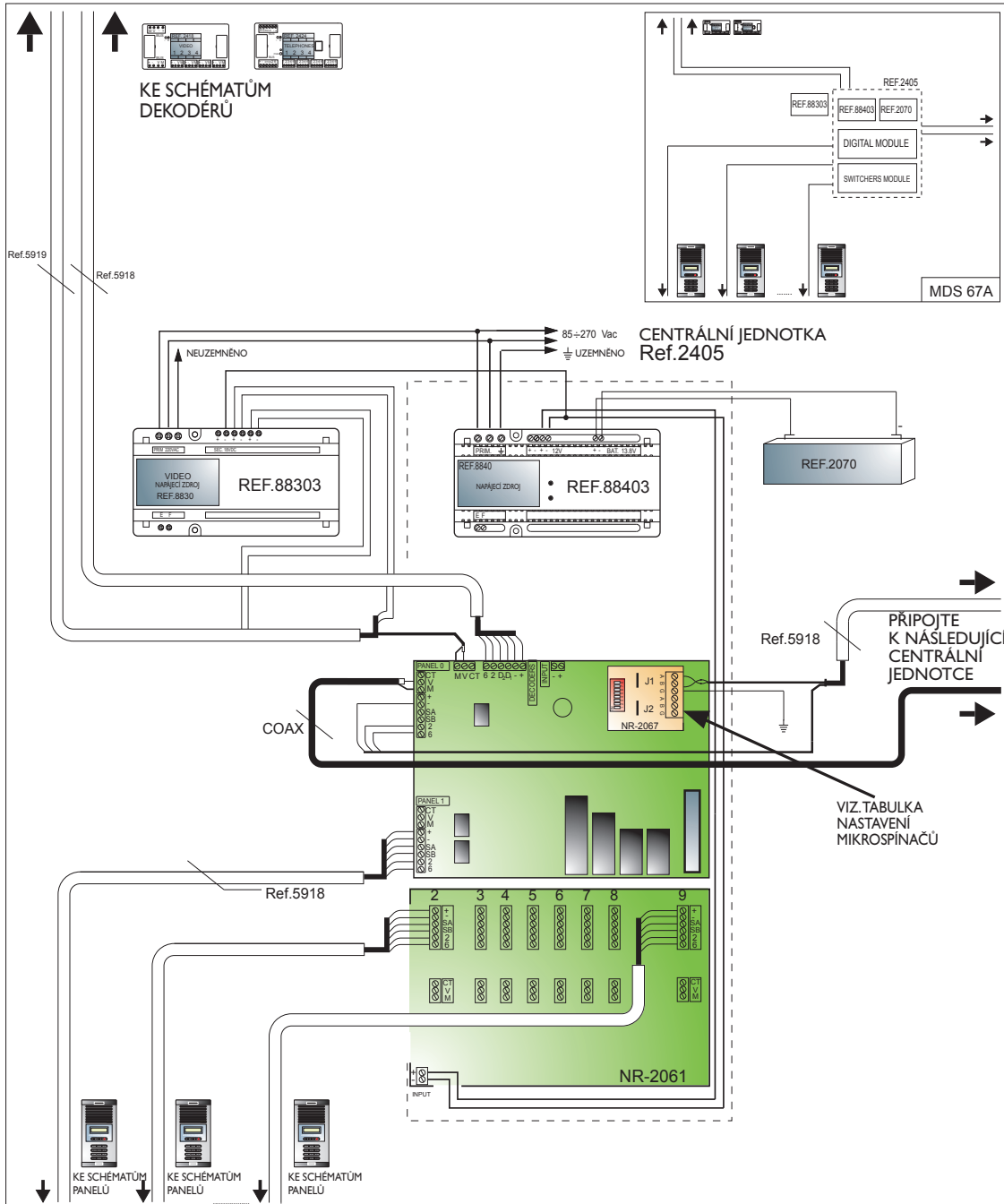

* V CELÉ INSTALACI BY MĚL BÝT UZEMNĚN POUZE NAPÁJECÍ ZDROJ

MDS 67A

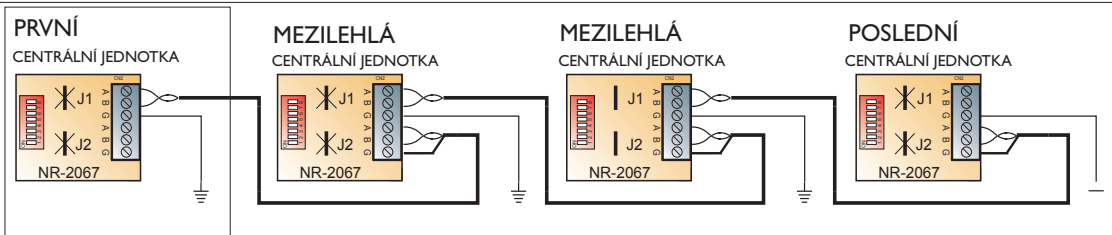

* STÍNĚNÍ KROUCENÉ DVOJLINKY SPOJUJÍCÍ DVĚ CENTRÁLNÍ JEDNOTKY MUSÍ BÝT UZEMNĚN POUZE V JEDNÉ CENTRÁLNÍ JEDNOTCE.

* U VŠECH CENTRÁLNÍCH JEDNOTEK, KROMĚ JEDNÉ Z MEZILEHLÝCH, PŘERUŠTE PROPOJKY J1 A J2.

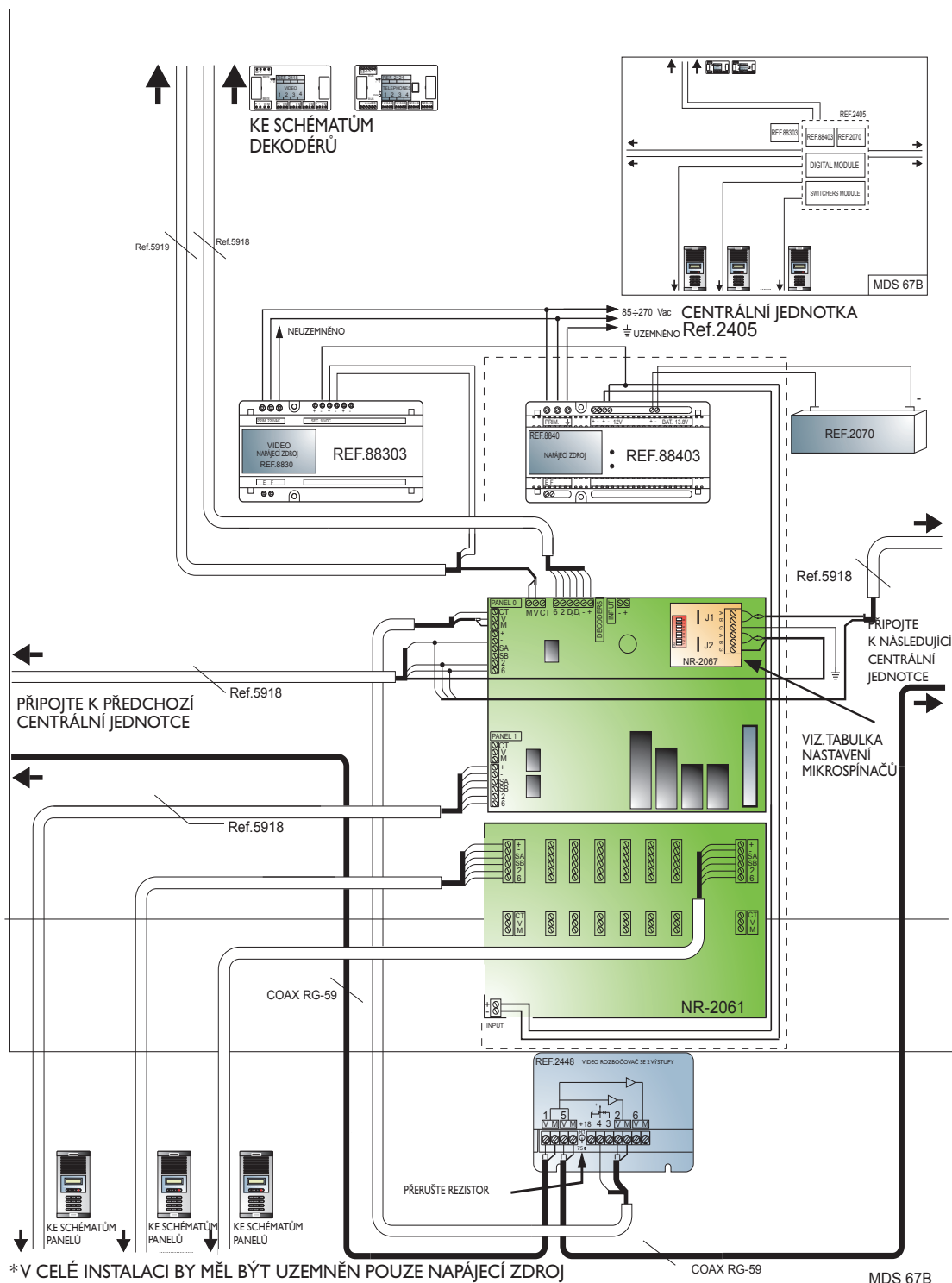

* V CELÉ INSTALACI BY MĚL BÝT UZEMNĚN POUZE NAPÁJECÍ ZDROJ

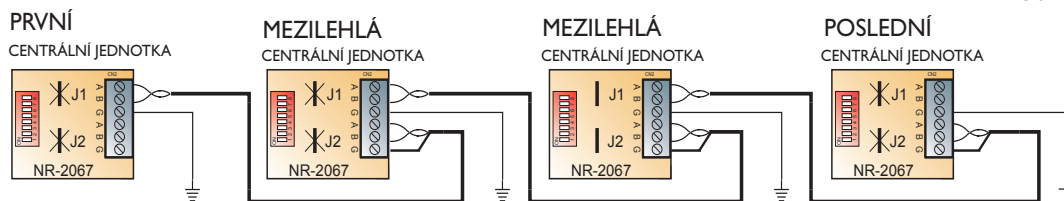

* STÍNĚNÍ KROUCENÉ DVOJLINKY SPOJUJÍCÍ DVĚ CENTRÁLNÍ JEDNOTKY MUSÍ BÝT UZEMNĚN POUZE V JEDNÉ CENTRÁLNÍ JEDNOTCE.

* U VŠECH CENTRÁLNÍCH JEDNOTEK, KROMĚ JEDNÉ Z MEZILEHLÝCH, PŘERUŠTE PROPOJKY J1 A J2.

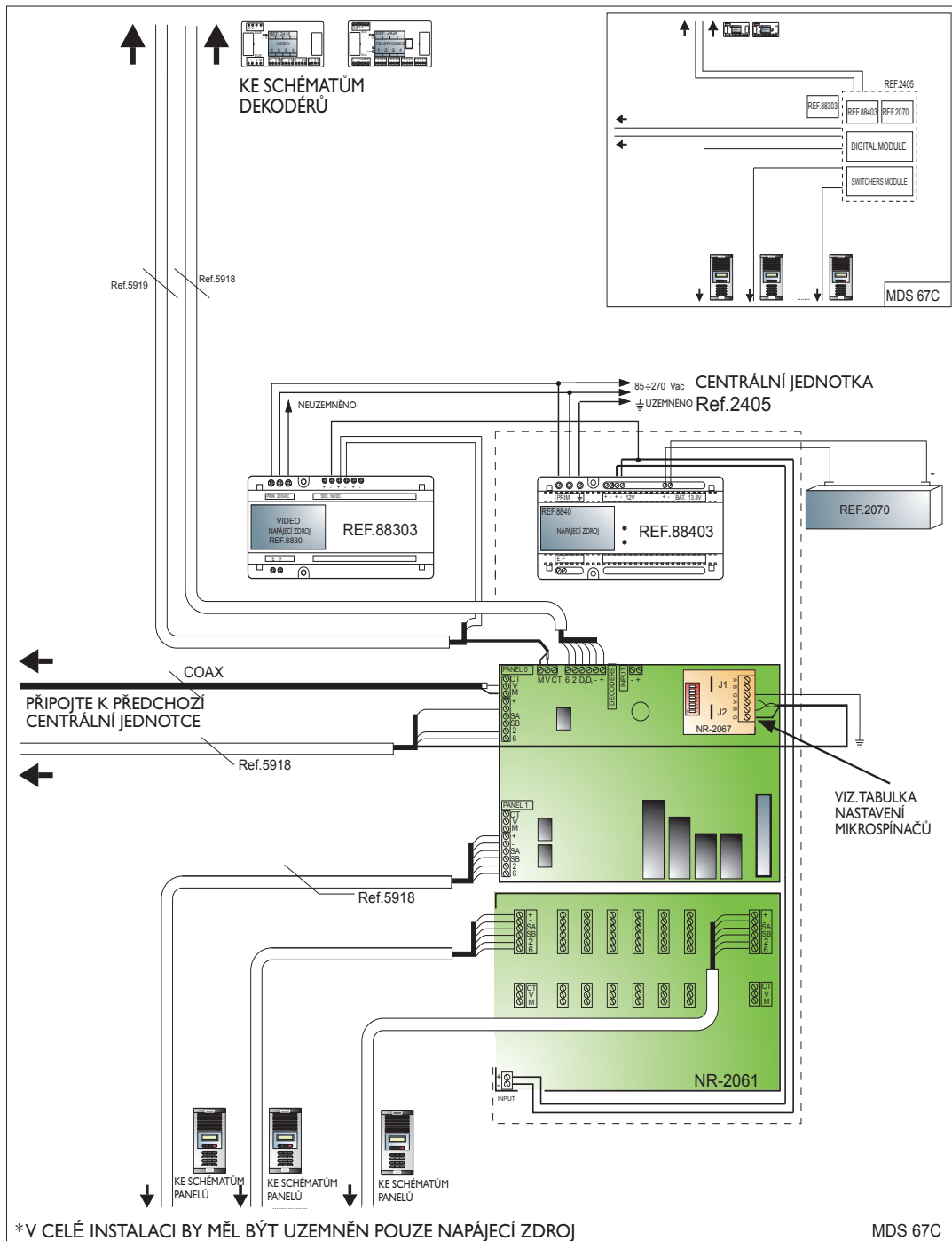

*V CELÉ INSTALACI BY MĚL BÝT UZEMNĚN POUZE NAPÁJECÍ ZDROJ

MDS 67C

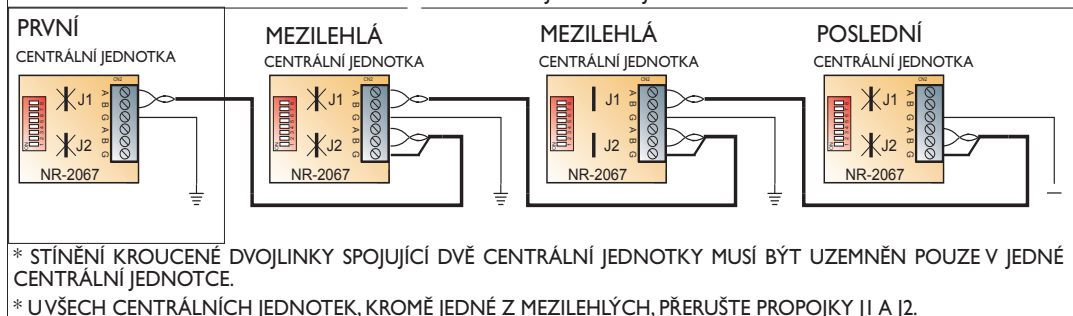

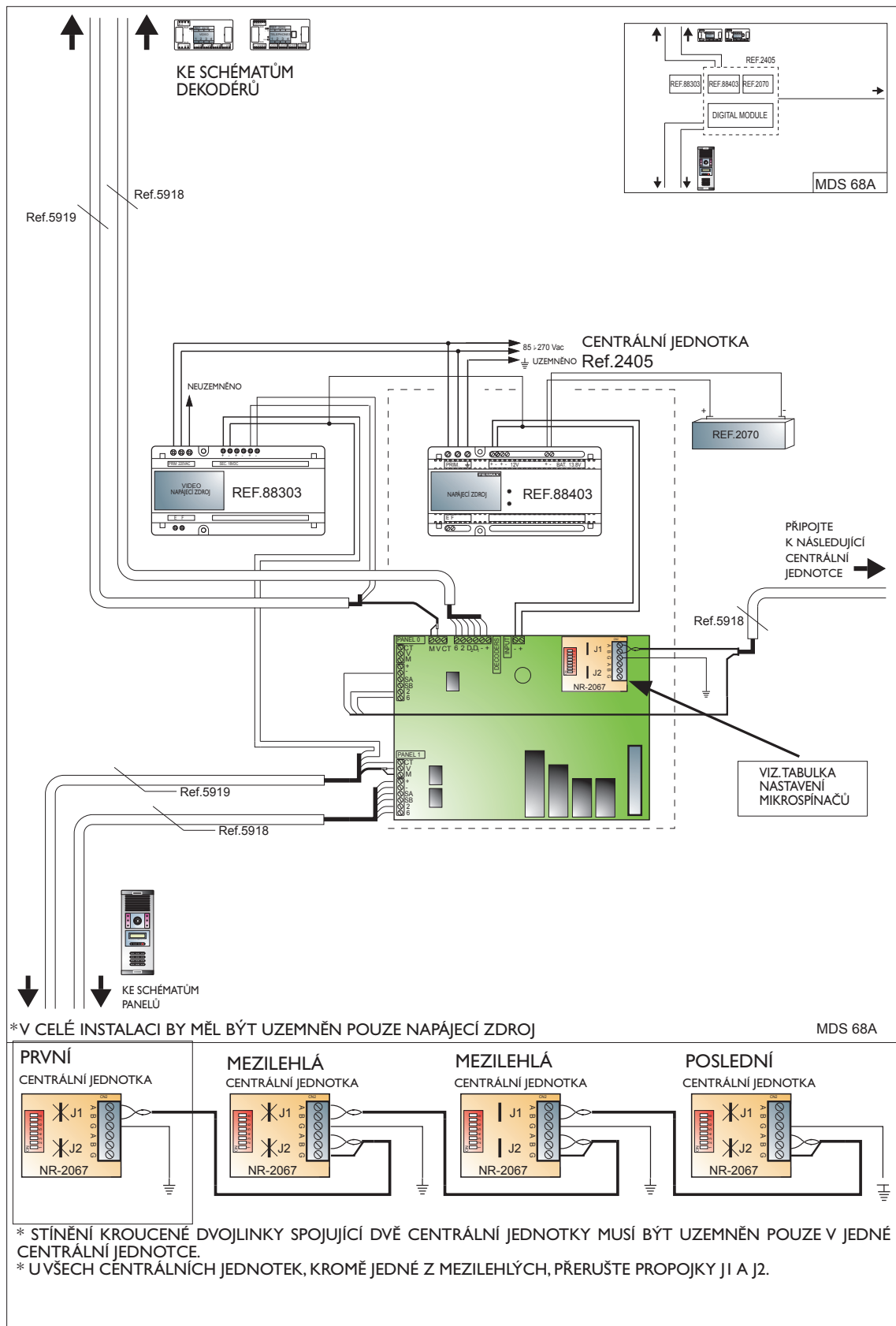

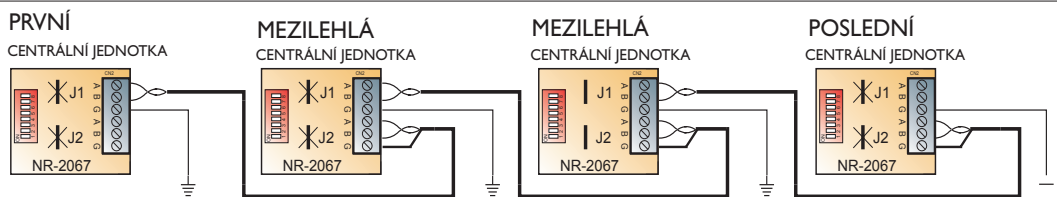
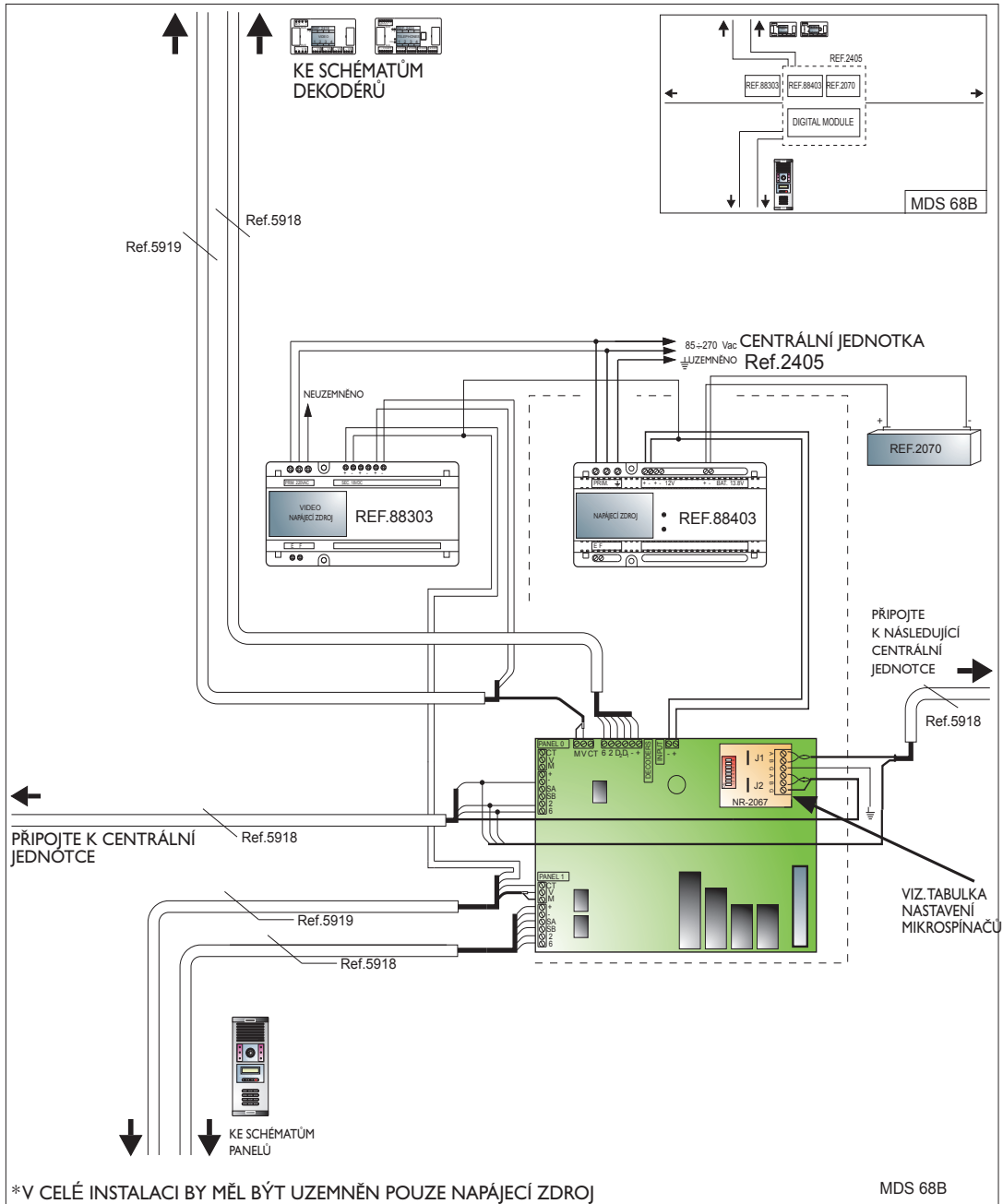

* STÍNĚNÍ KROUCENÉ DVOJLINKY SPOJUJÍCÍ DVĚ CENTRÁLNÍ JEDNOTKY MUSÍ BÝT UZEMNĚN POUZE V JEDNÉ CENTRÁLNÍ JEDNOTCE.

* U VŠECH CENTRÁLNÍCH JEDNOTEK, KROMĚ JEDNÉ Z MEZILEHLÝCH, PŘERUŠTE PROPOJKY J1 A J2.

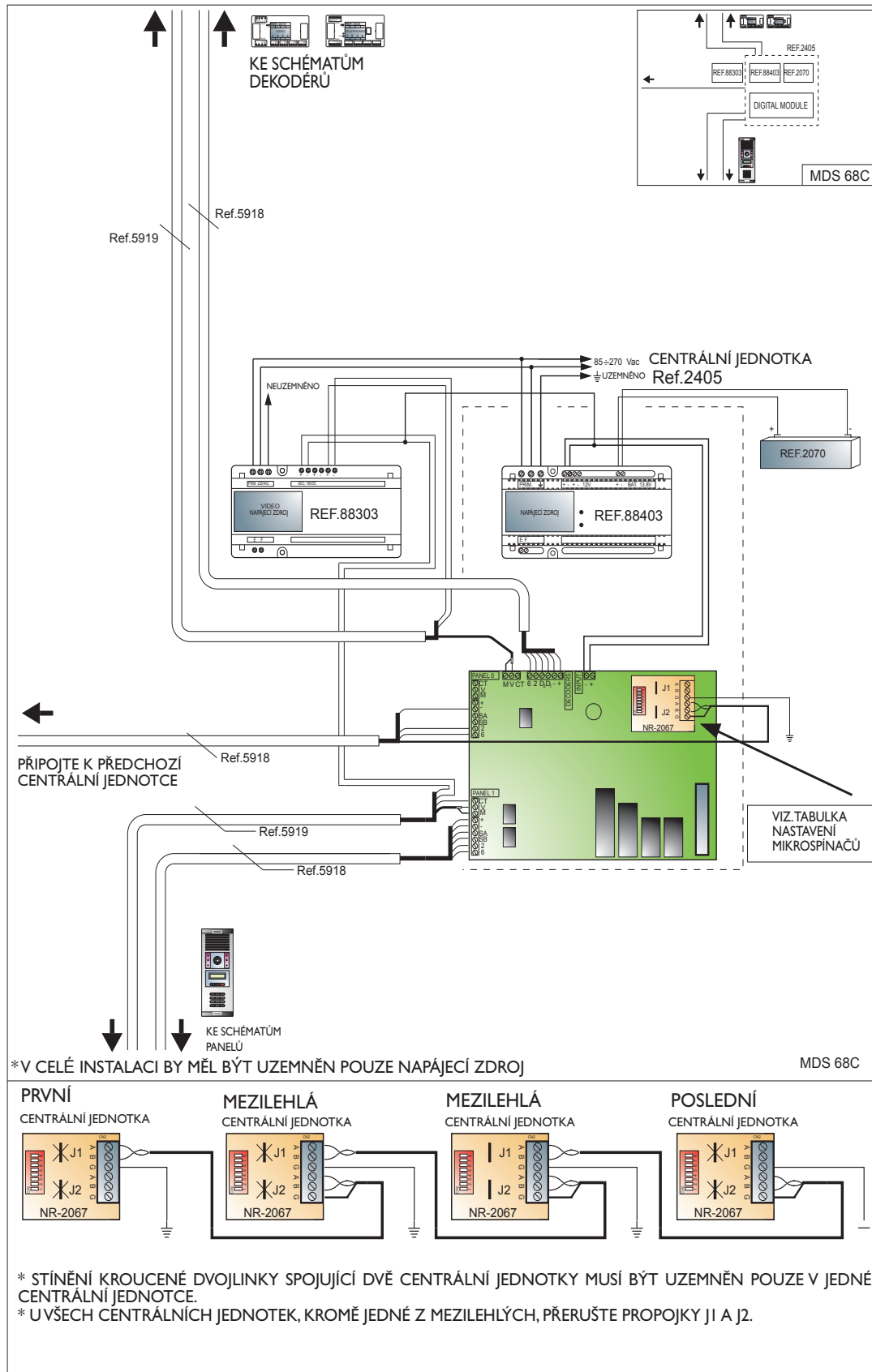

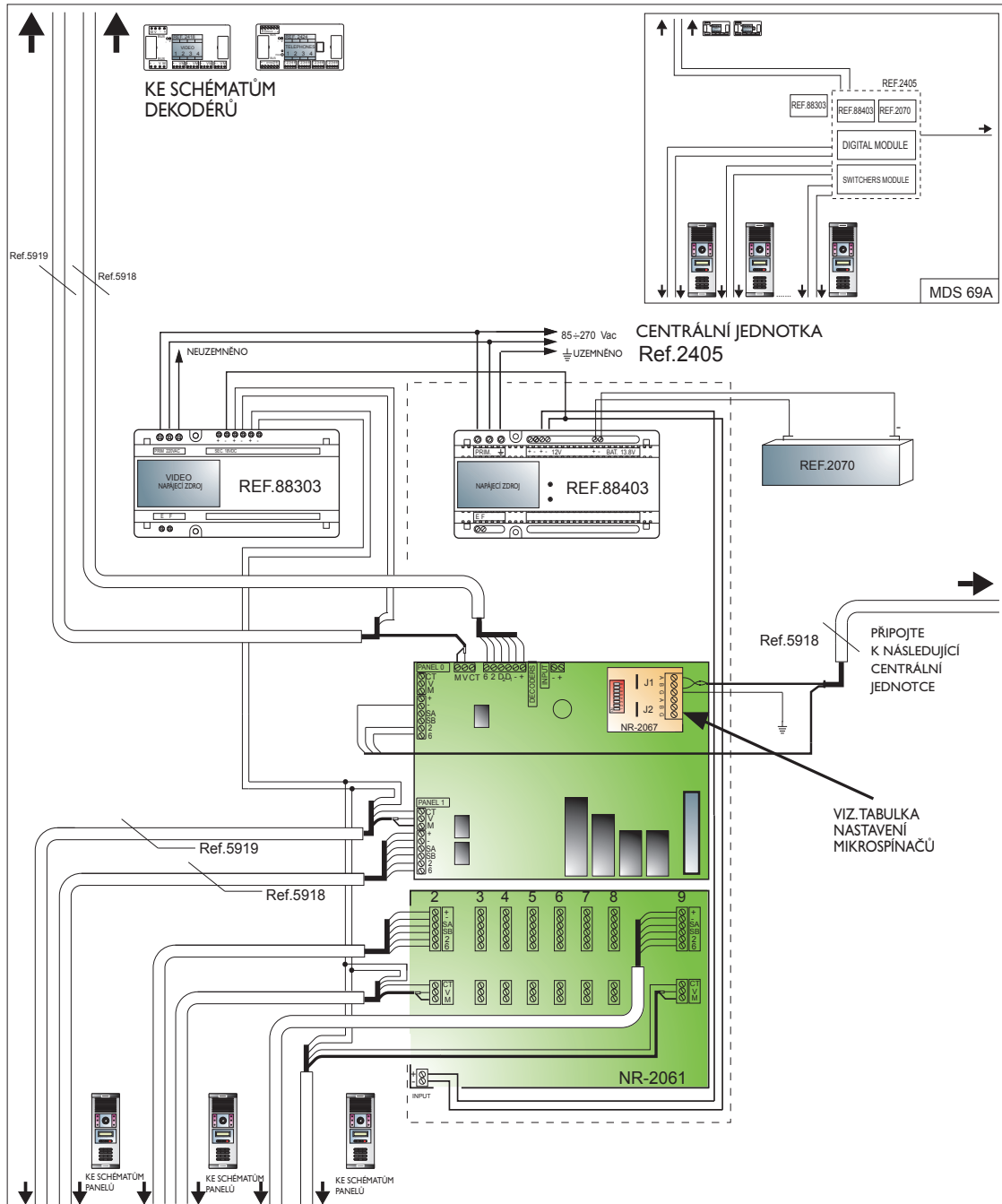

* V CELÉ INSTALACI BY MĚL BÝT UZEMNĚN POUZE NAPÁJECÍ ZDROJ MDS 69A

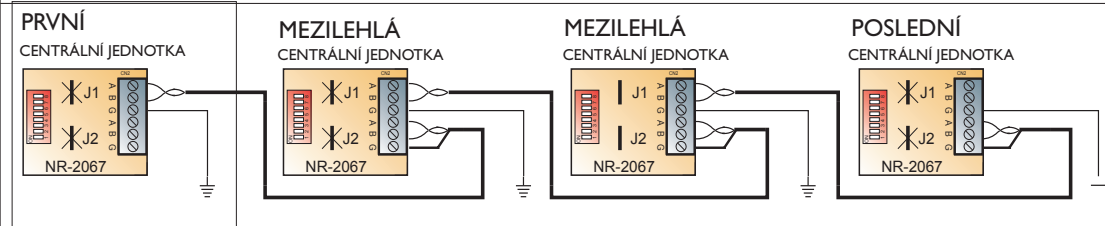

* STÍNĚNÍ KROUCENÉ DVOJLINKY SPOJUJÍCÍ DVĚ CENTRÁLNÍ JEDNOTKY MUSÍ BÝT UZEMNĚN POUZE V JEDNÉ CENTRÁLNÍ JEDNOTCE.
 * U VŠECH CENTRÁLNÍCH JEDNOTEK, KROMĚ JEDNÉ Z MEZILEHLÝCH, PŘERUŠTE PROPOJKY J1 A J2.

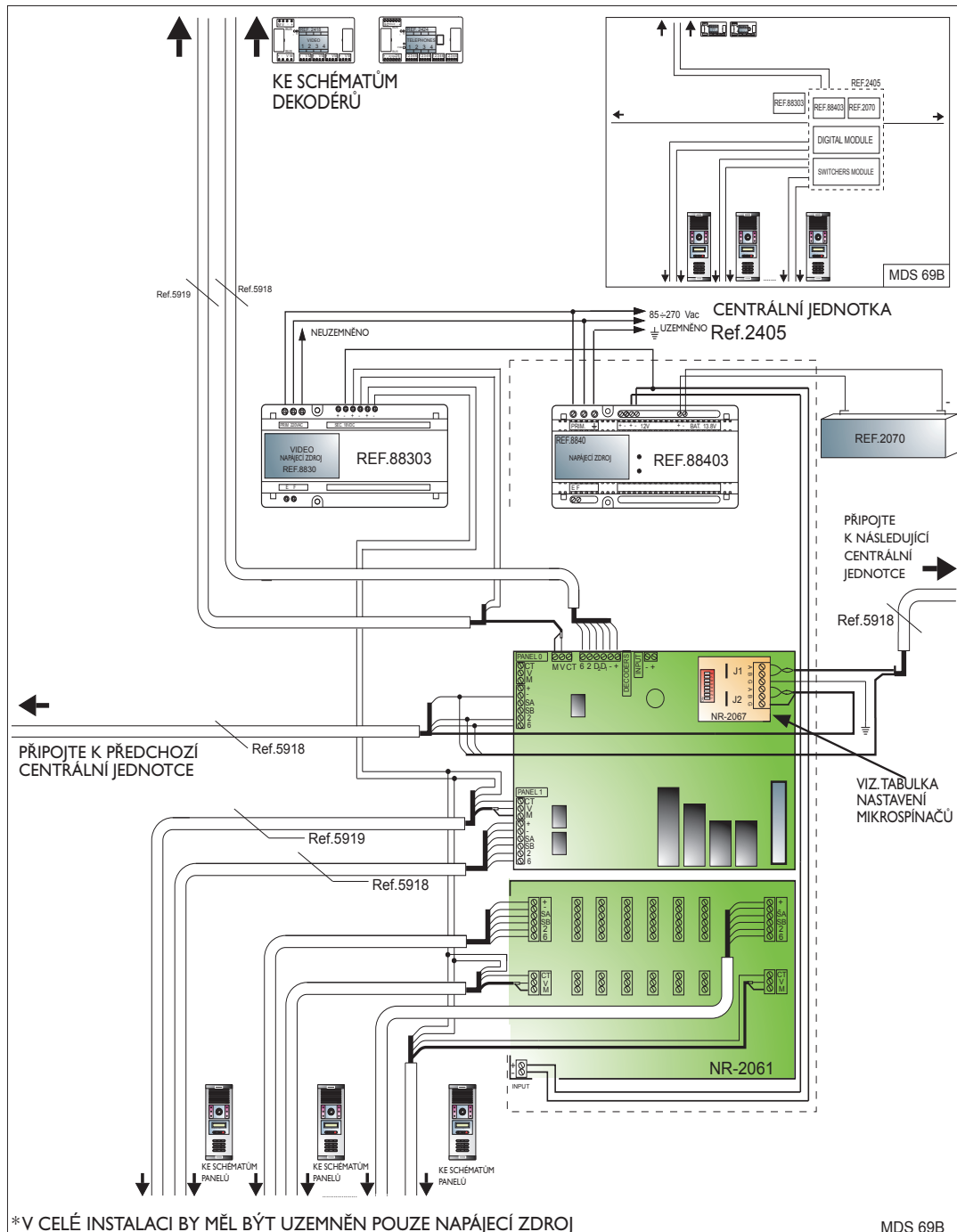

* V CELÉ INSTALACI BY MĚL BÝT UZEMNĚN POUZE NAPÁJECÍ ZDROJ

MDS 69B

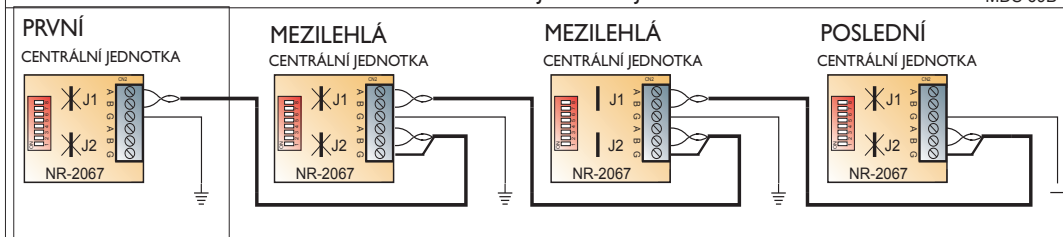

* STÍNĚNÍ KROUČENÉ DVOJLINKY SPOJUJÍCÍ DĚ CENTRÁLNÍ JEDNOTKY MUSÍ BÝT UZEMNĚN POUZE V JEDNĚ CENTRÁLNÍ JEDNOTCE.

* U VŠECH CENTRÁLNÍCH JEDNOTEK, KROMĚ JEDNÉ Z MEZILEHLÝCH, PŘERUŠTE PROPOJKY J1 A J2.

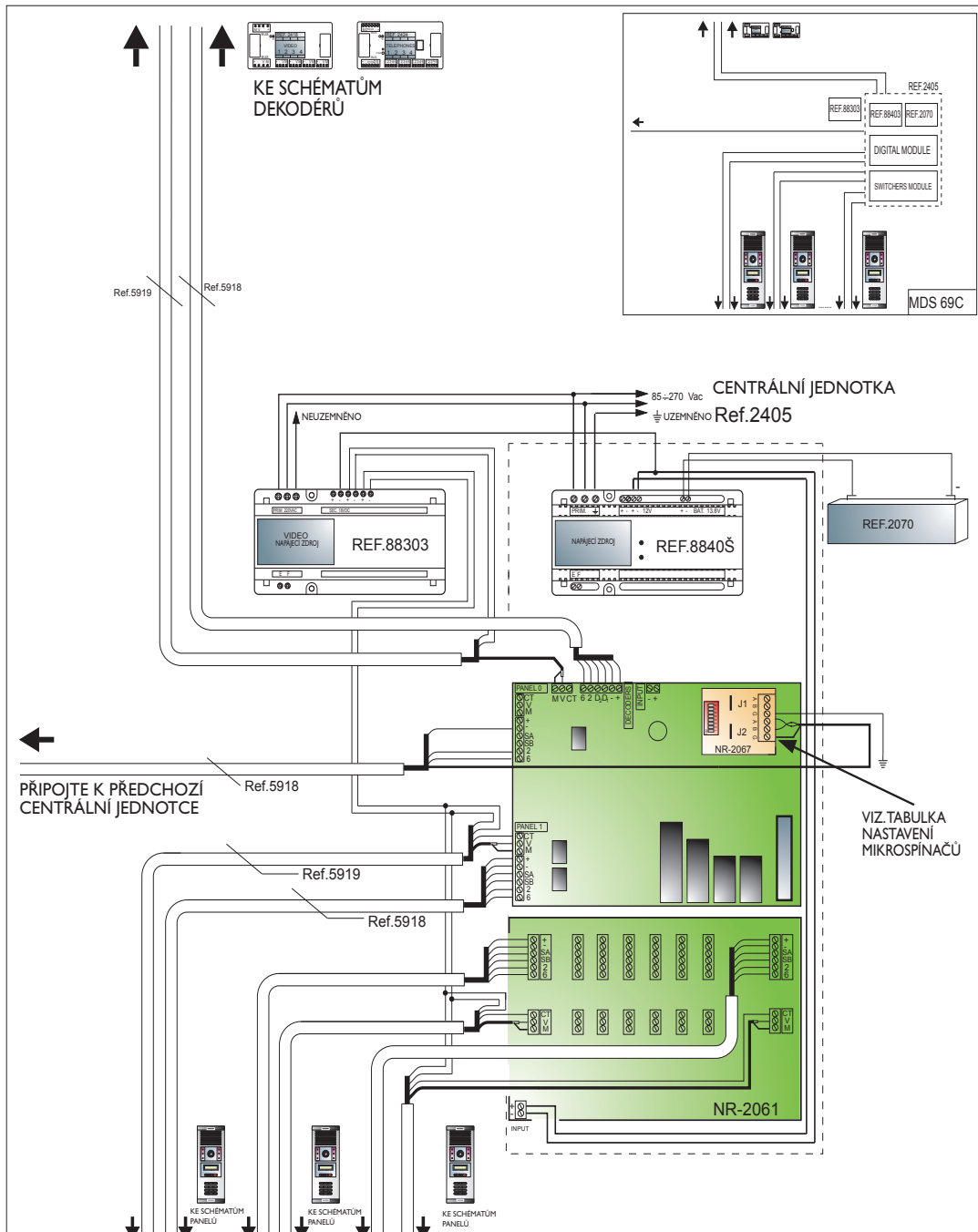

*V CELÉ INSTALACI BY MĚL BÝT UZEMNĚN POUZE NAPÁJECÍ ZDROJ

MDS 69C

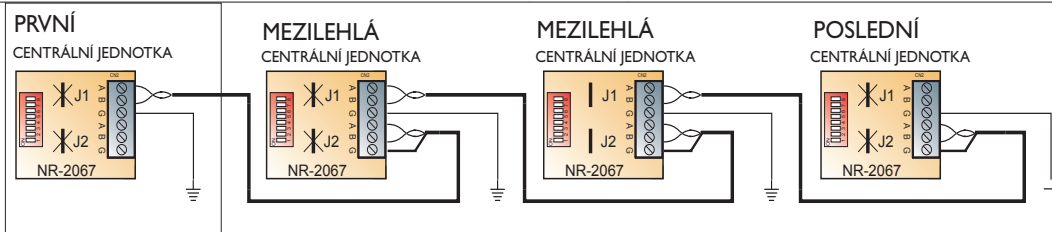

* STÍNĚNÍ KROUČENÉ DVOJLINKY SPOJUJÍCÍ DVĚ CENTRÁLNÍ JEDNOTKY MUSÍ BÝT UZEMNĚN POUZE V JEDNÉ CENTRÁLNÍ JEDNOTCE.

* U VŠECH CENTRÁLNÍCH JEDNOTEK, KROMĚ JEDNÉ Z MEZILEHLÝCH, PŘERUŠTE PROPOJKY J1 A J2.

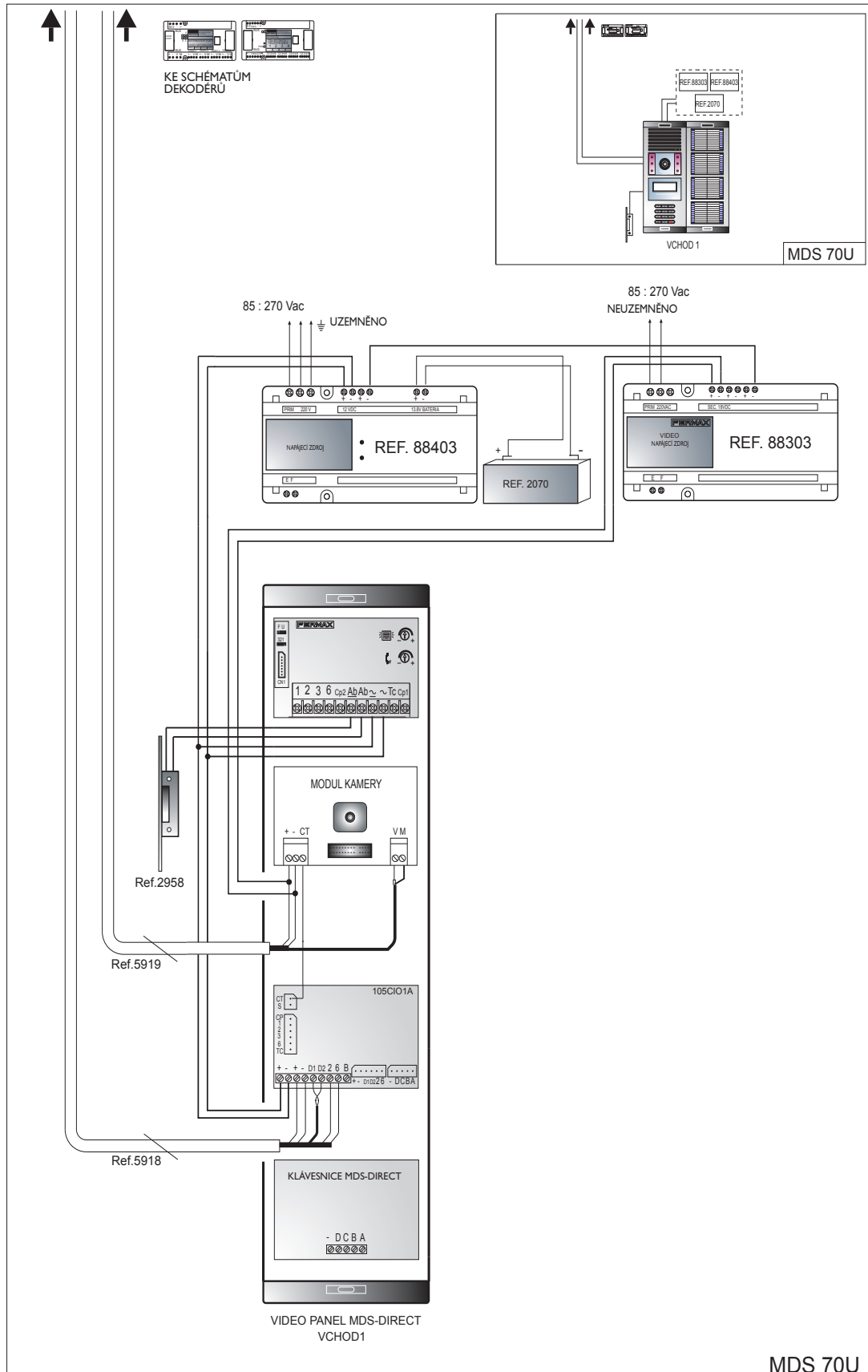

MDS 71U

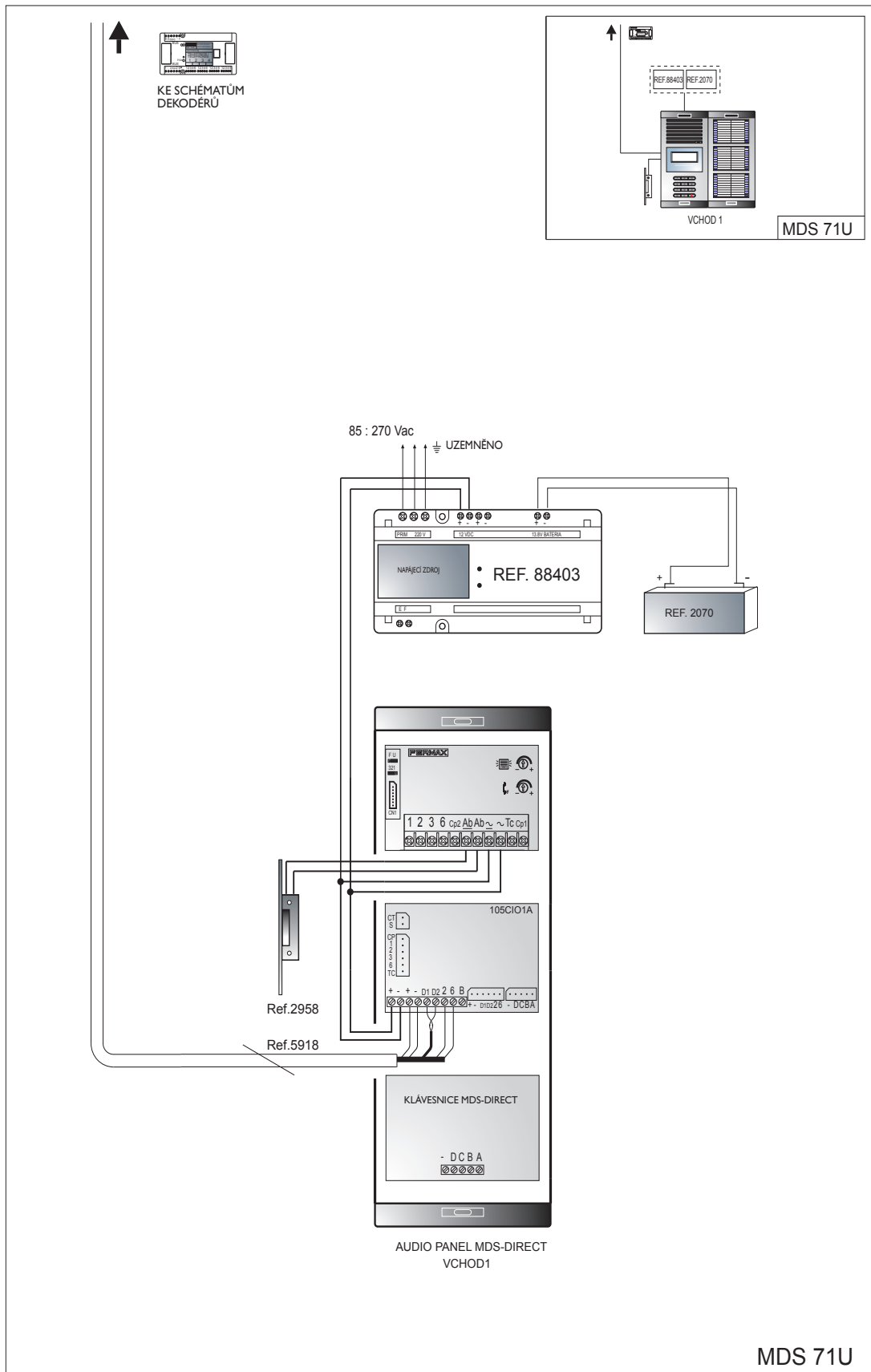

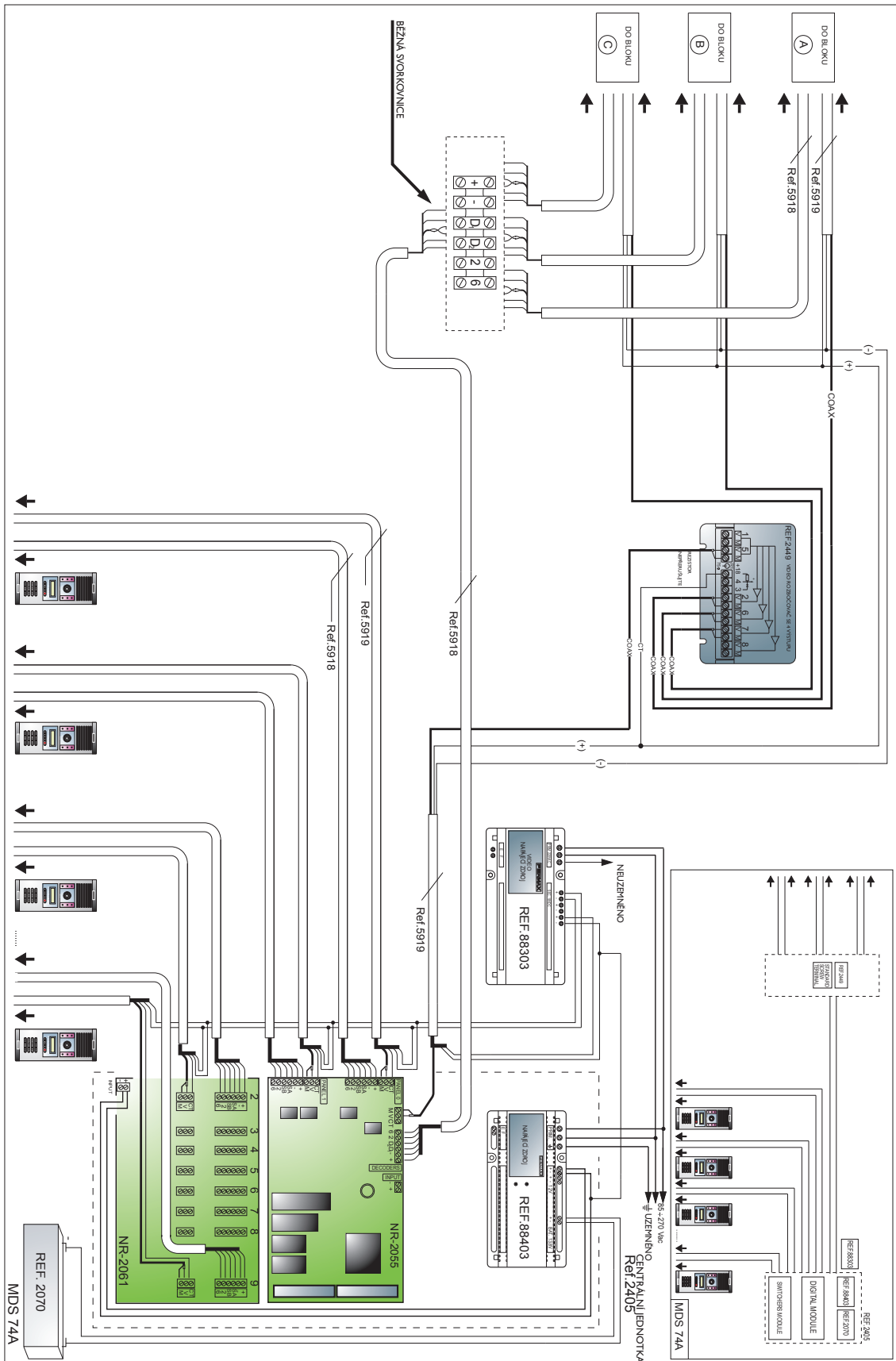

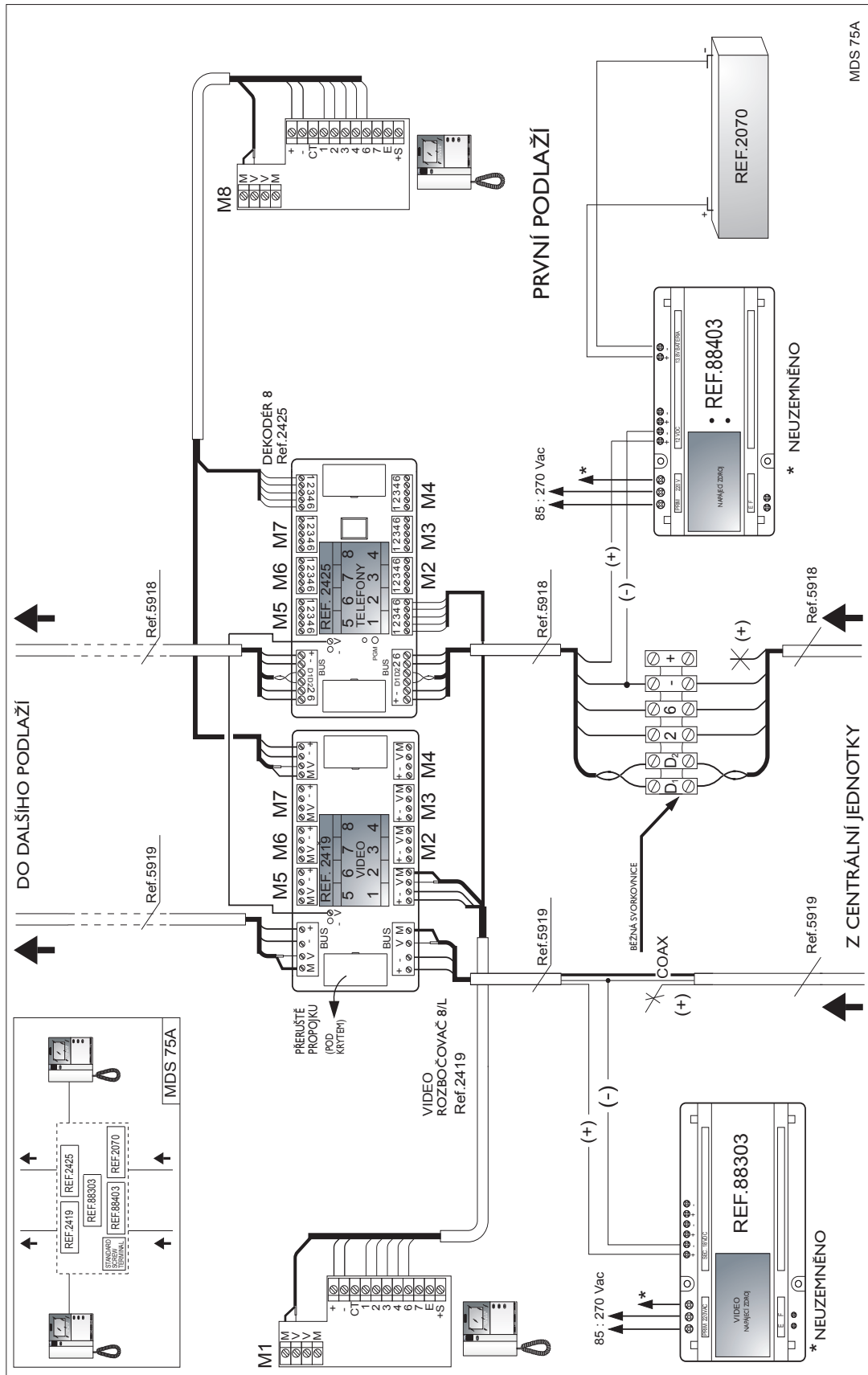

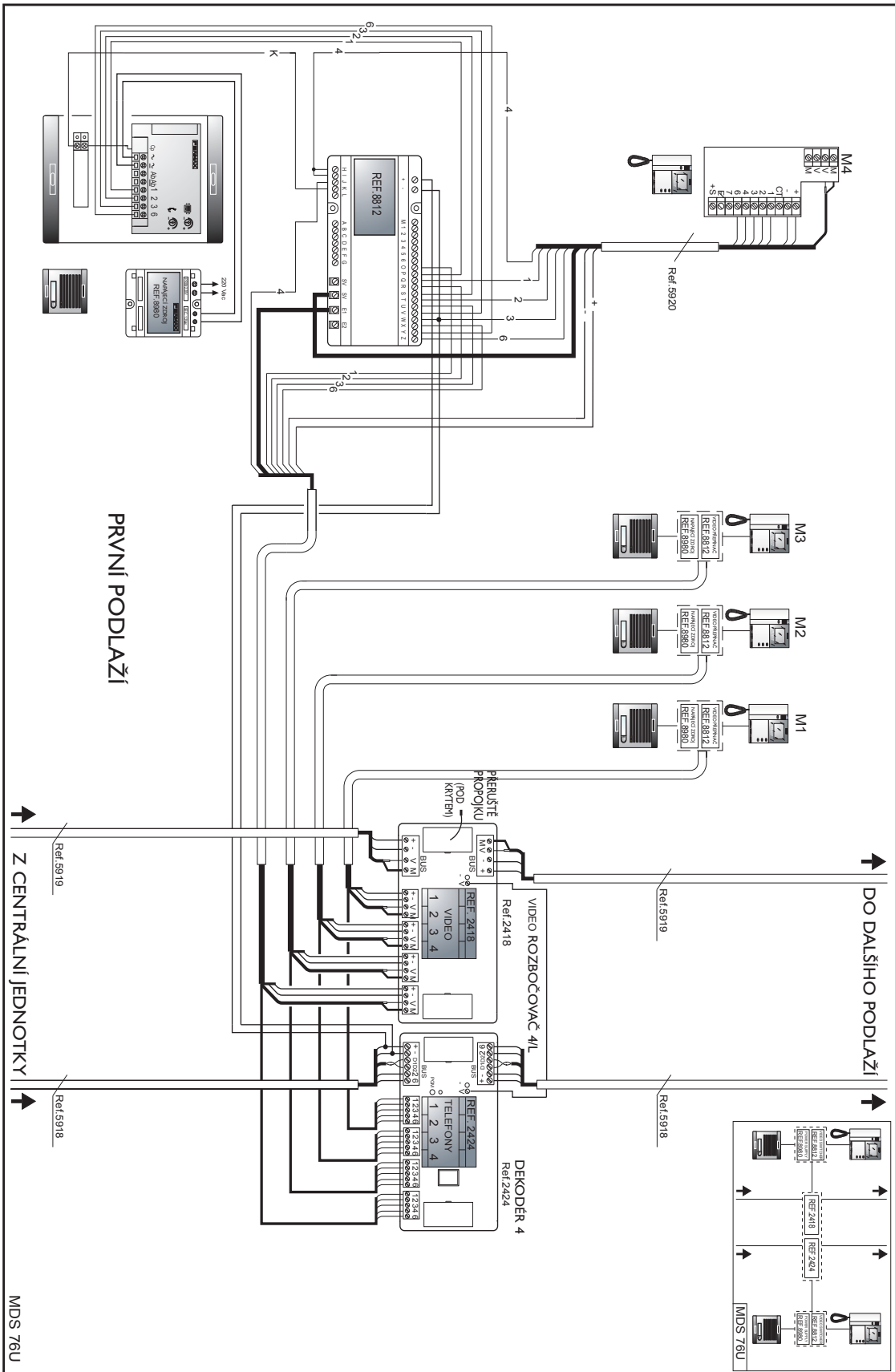

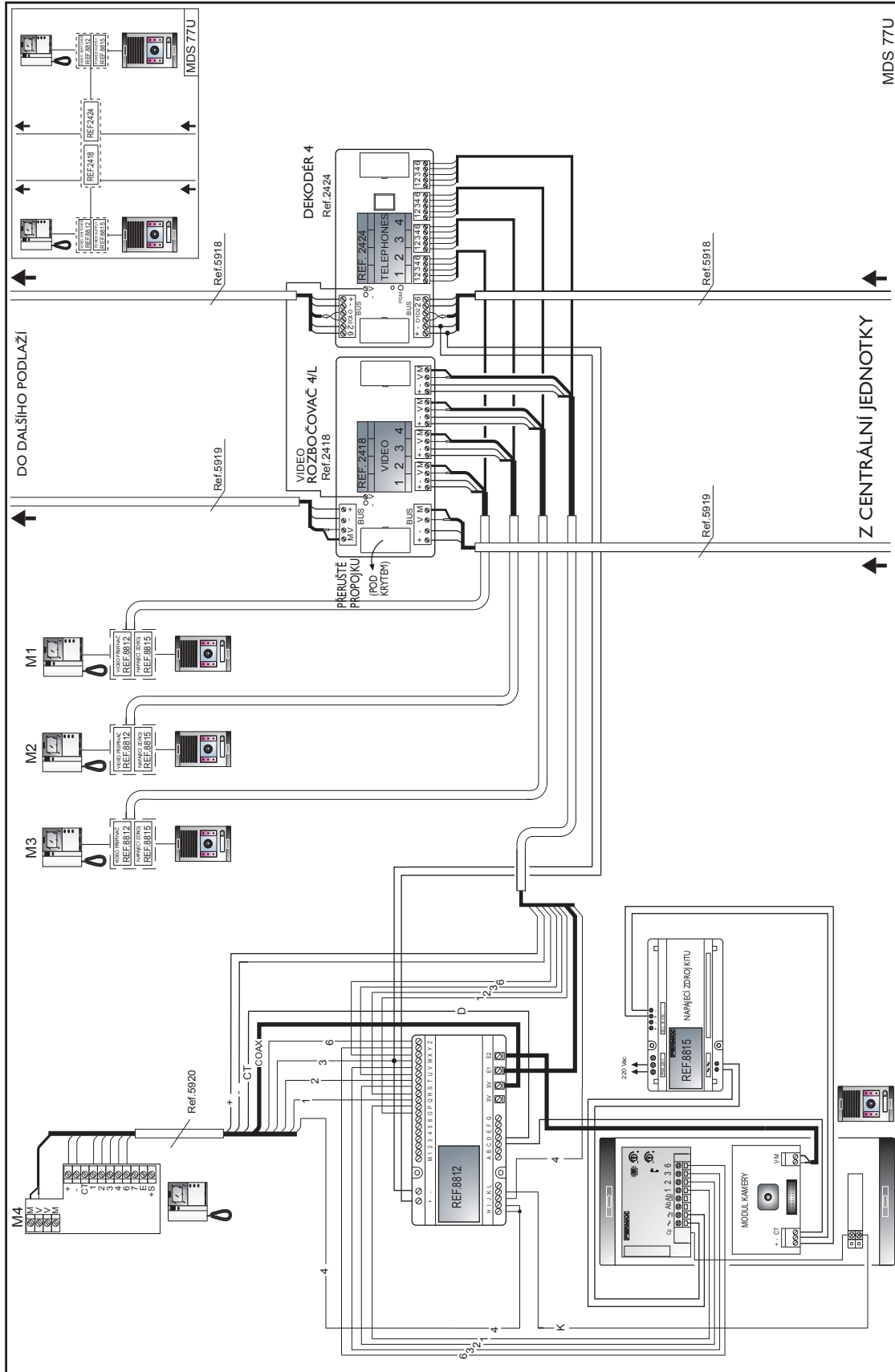

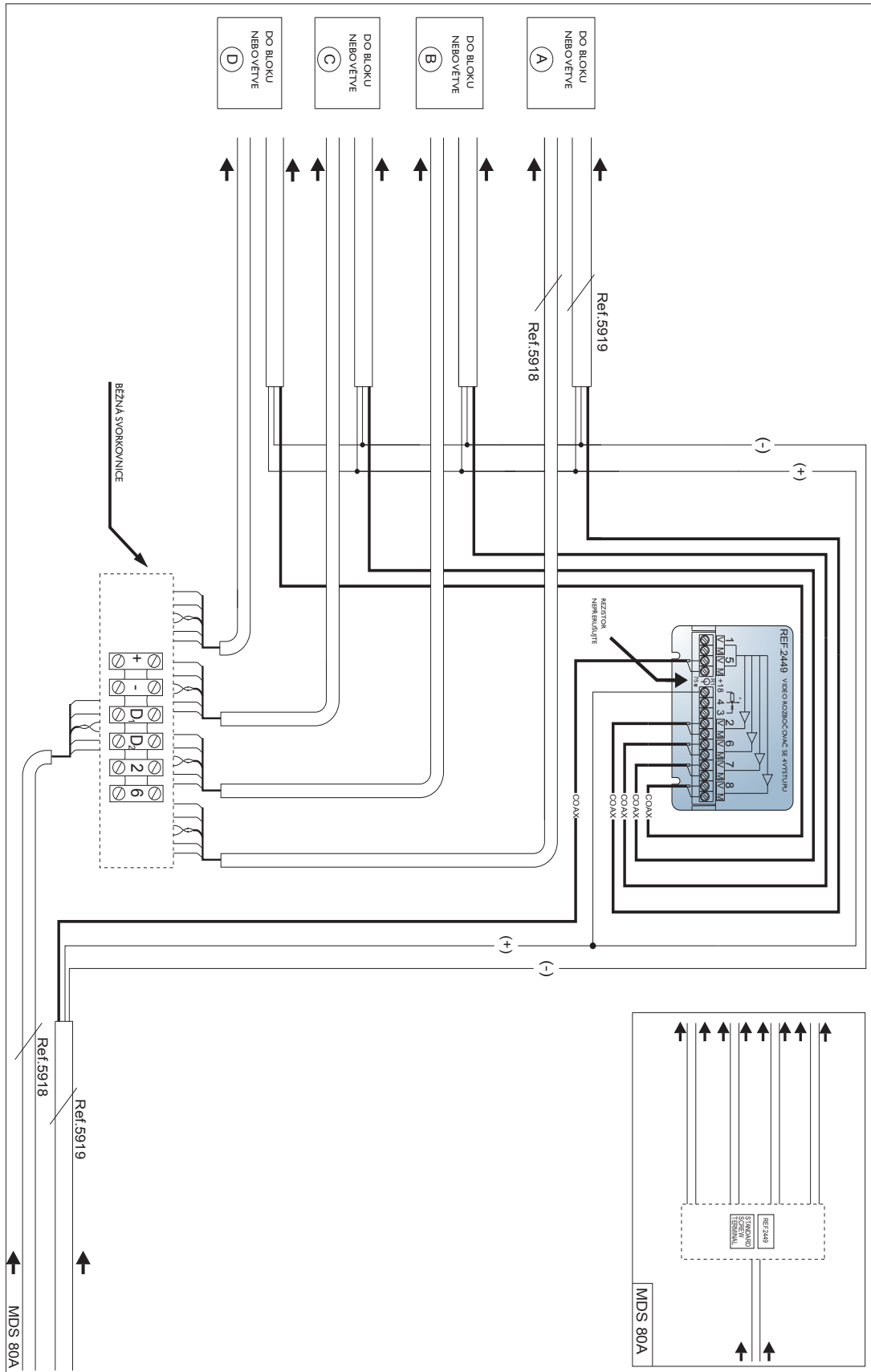

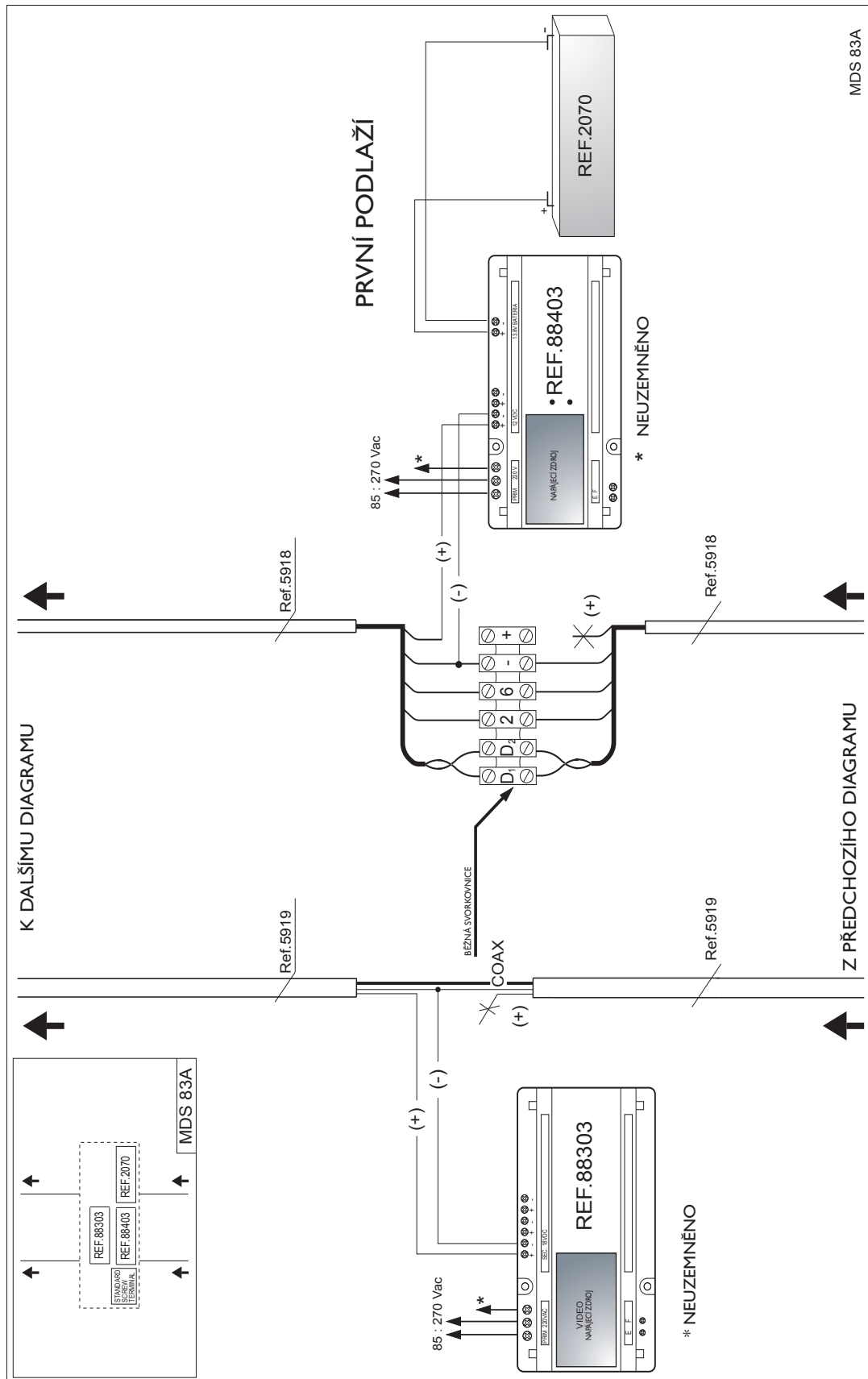

MDS 83A

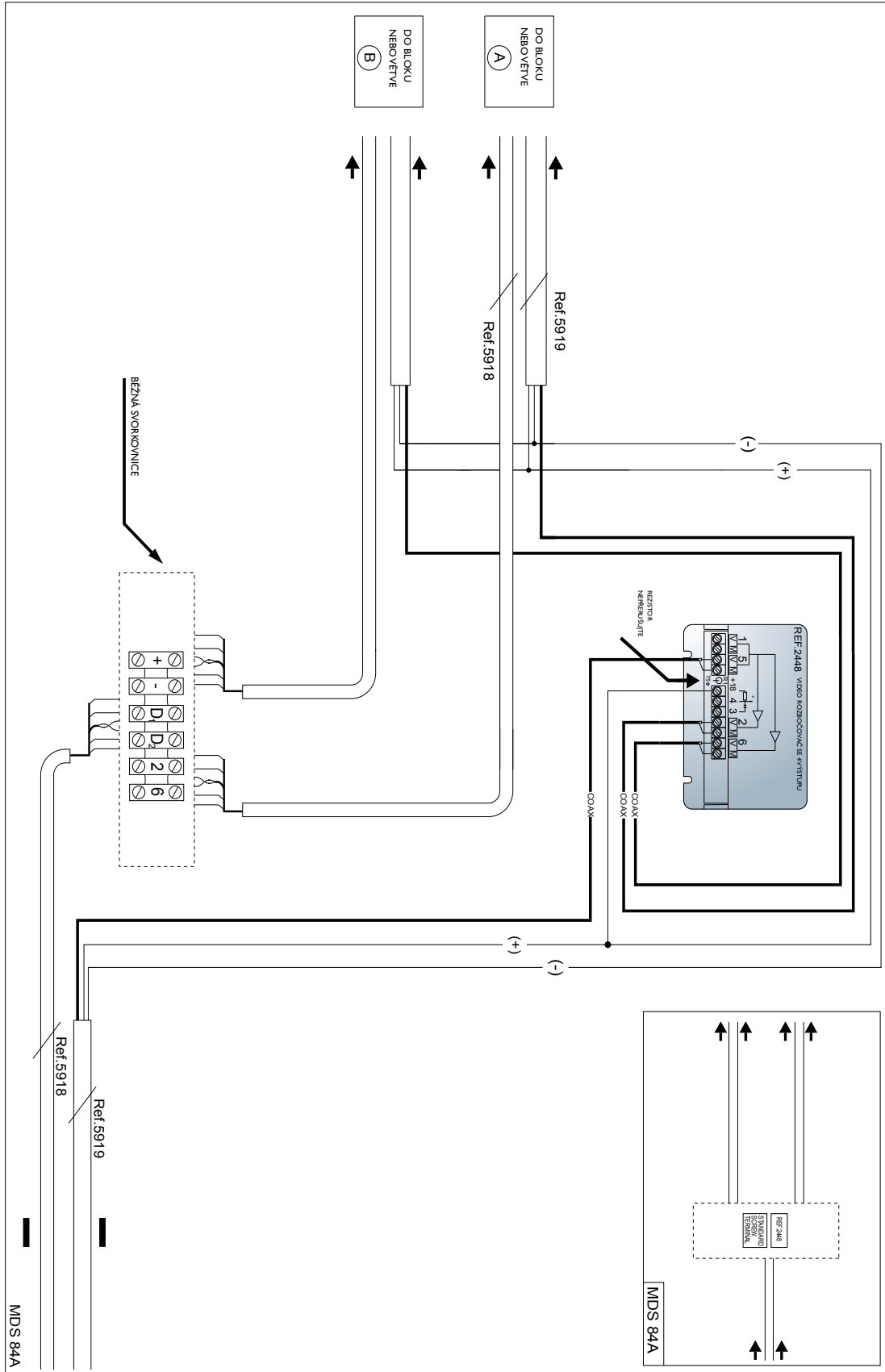

MDS 87U

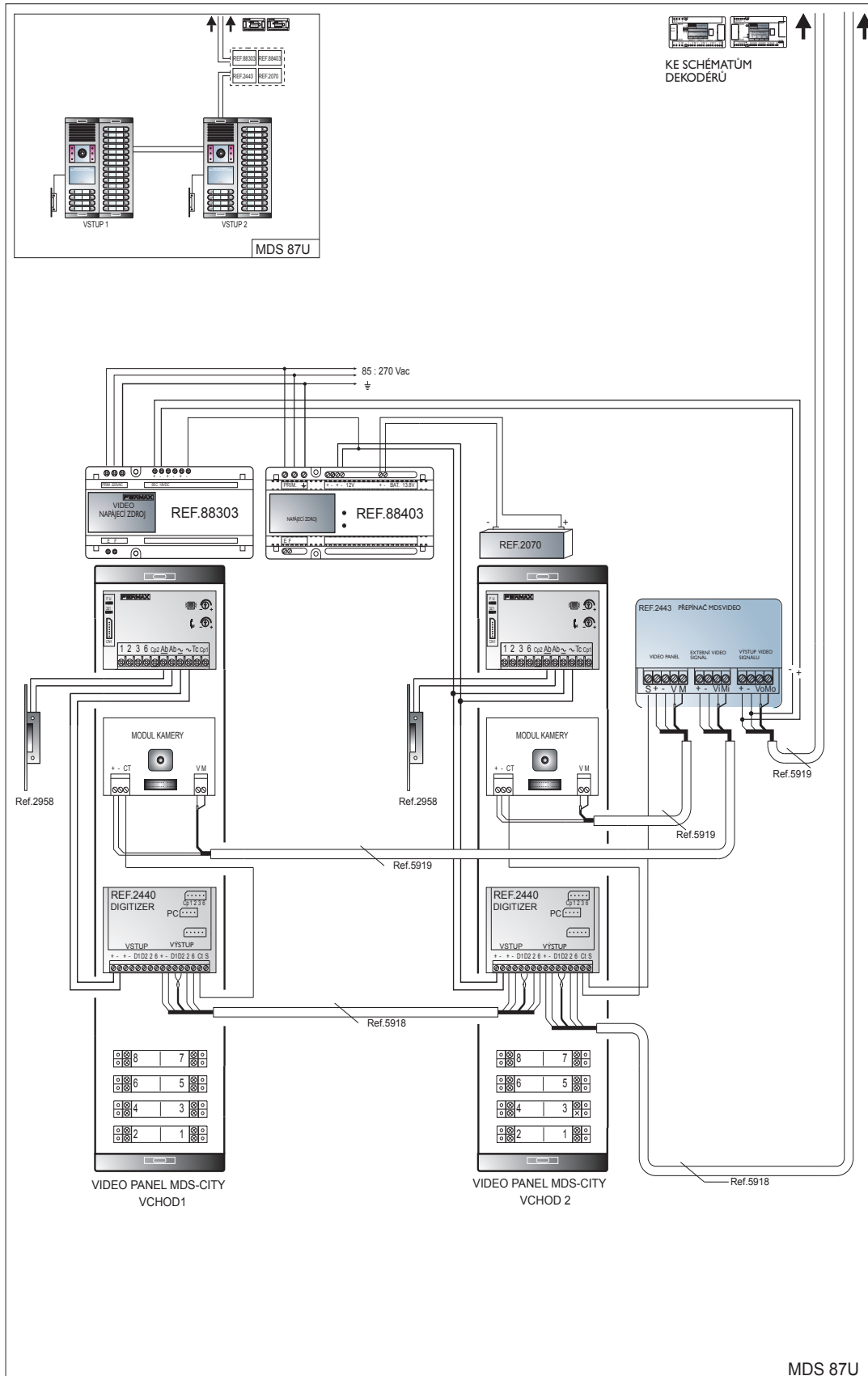

MDS 90A

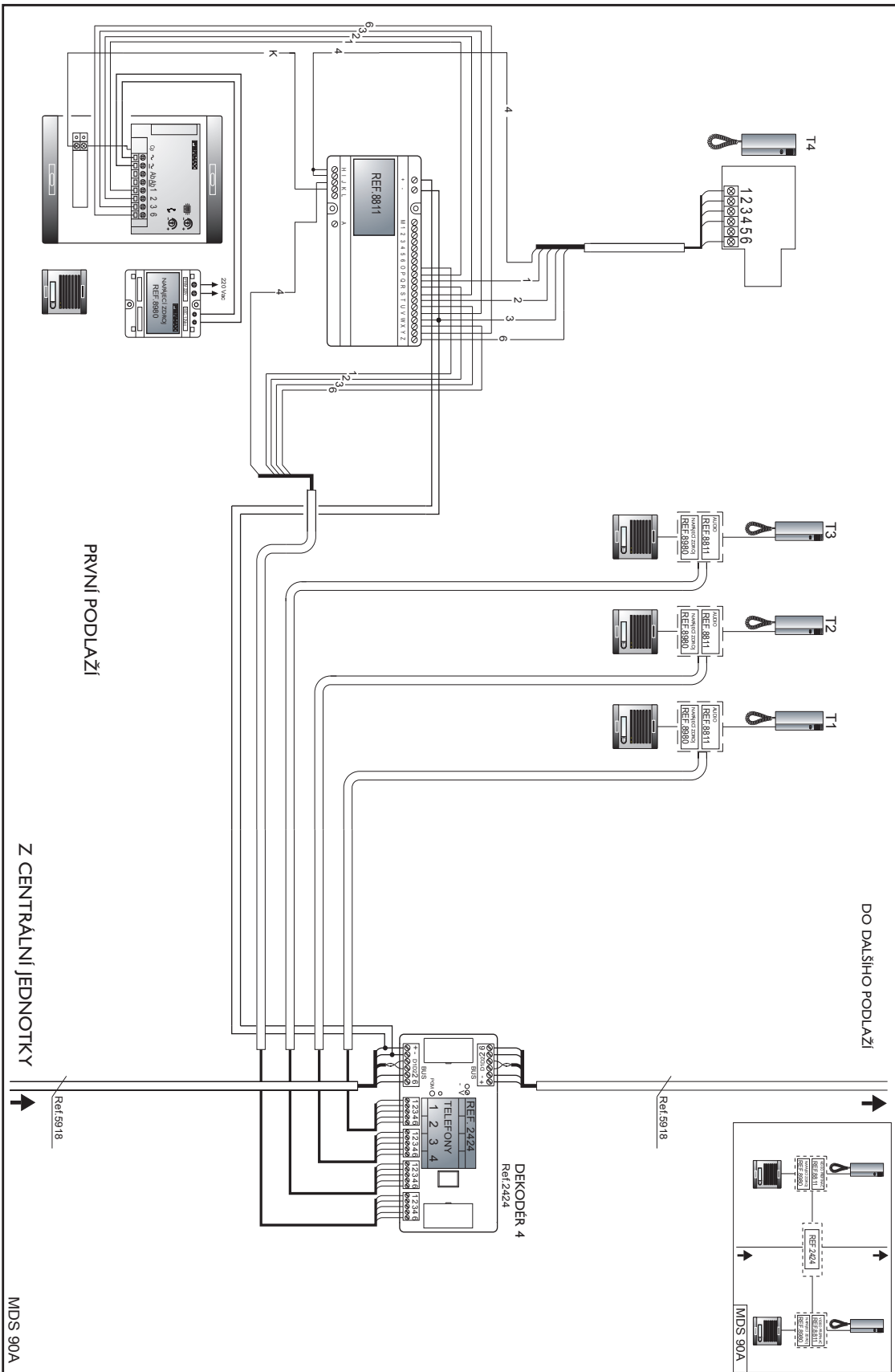

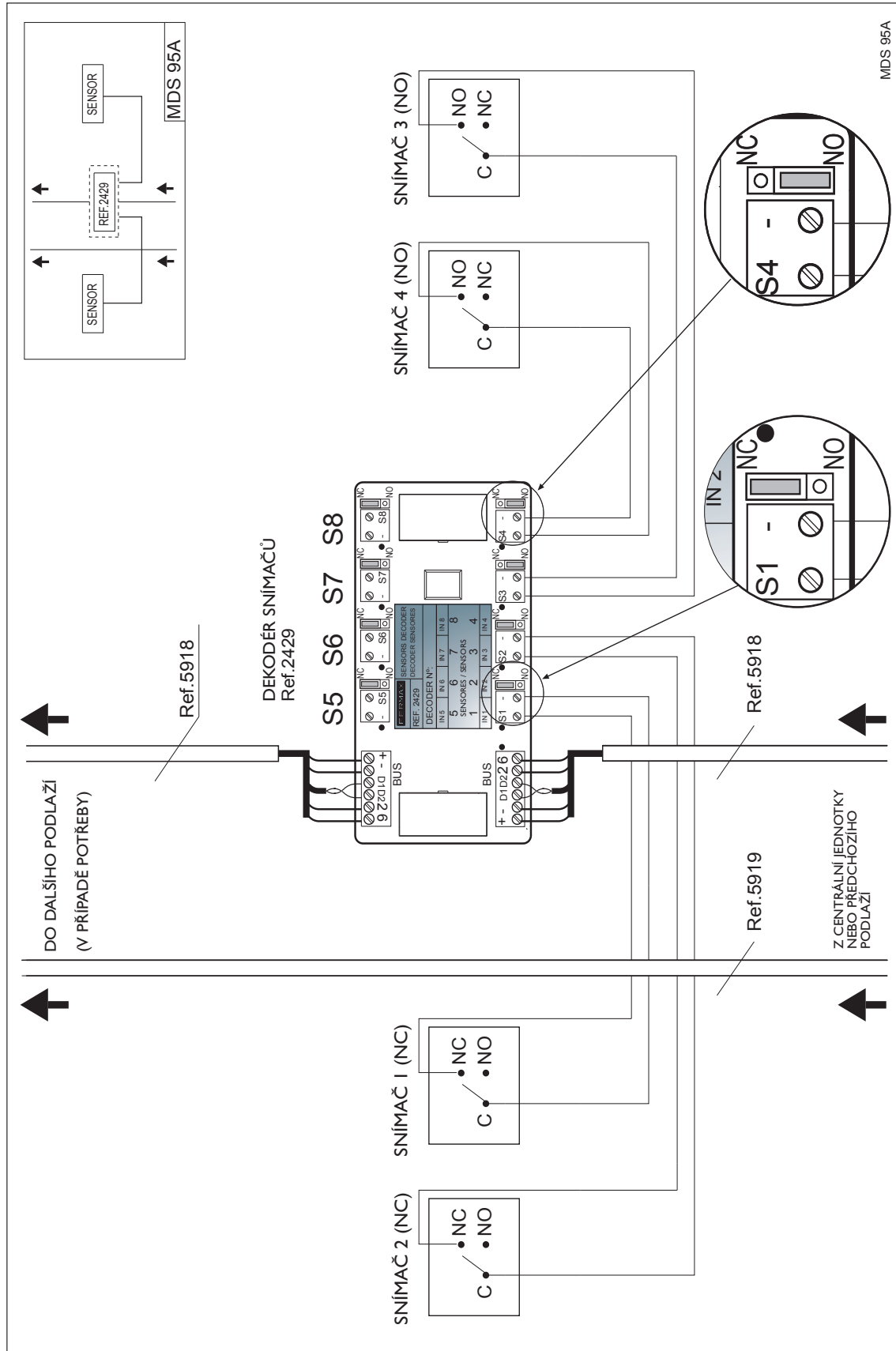

MDS 95A

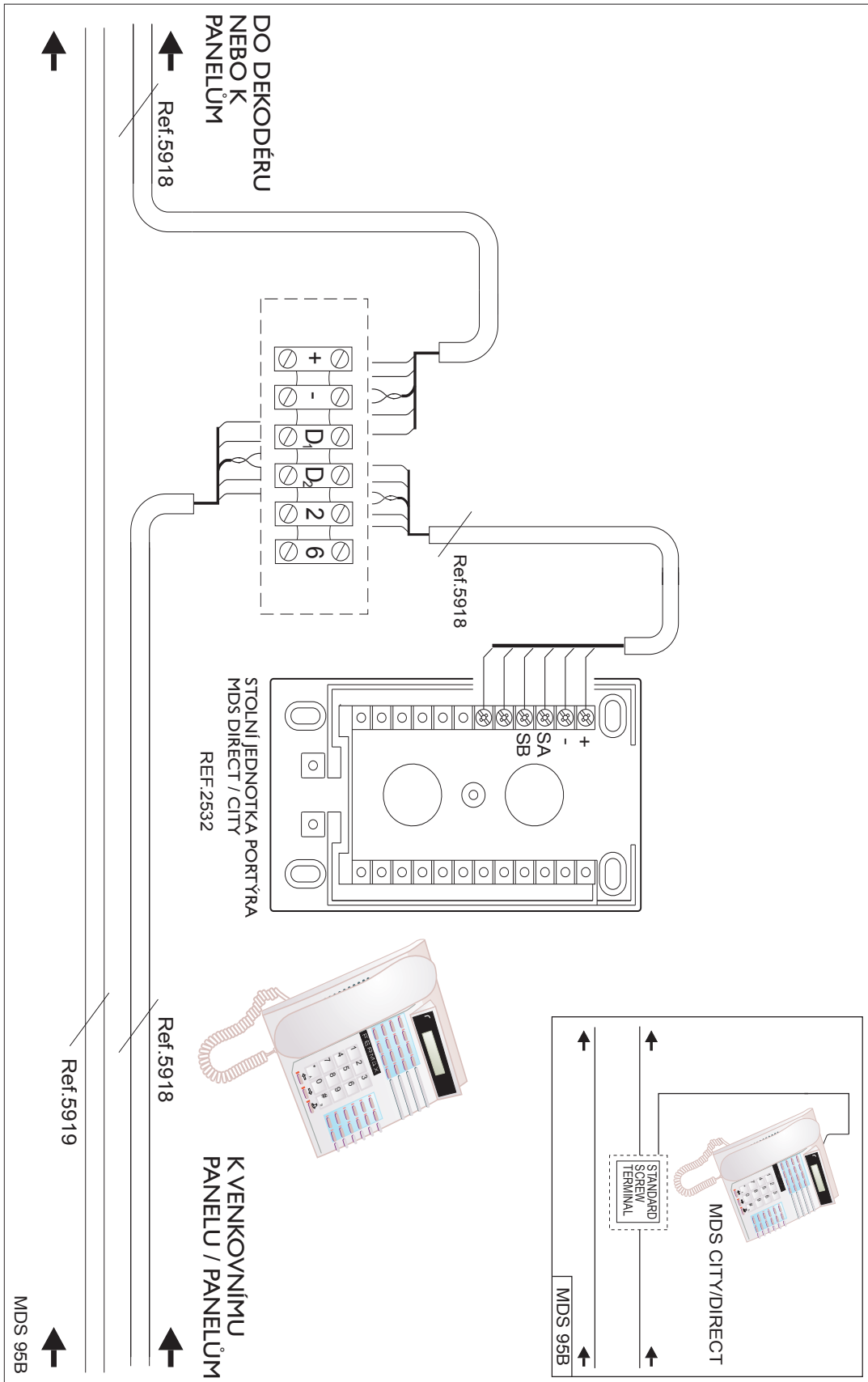

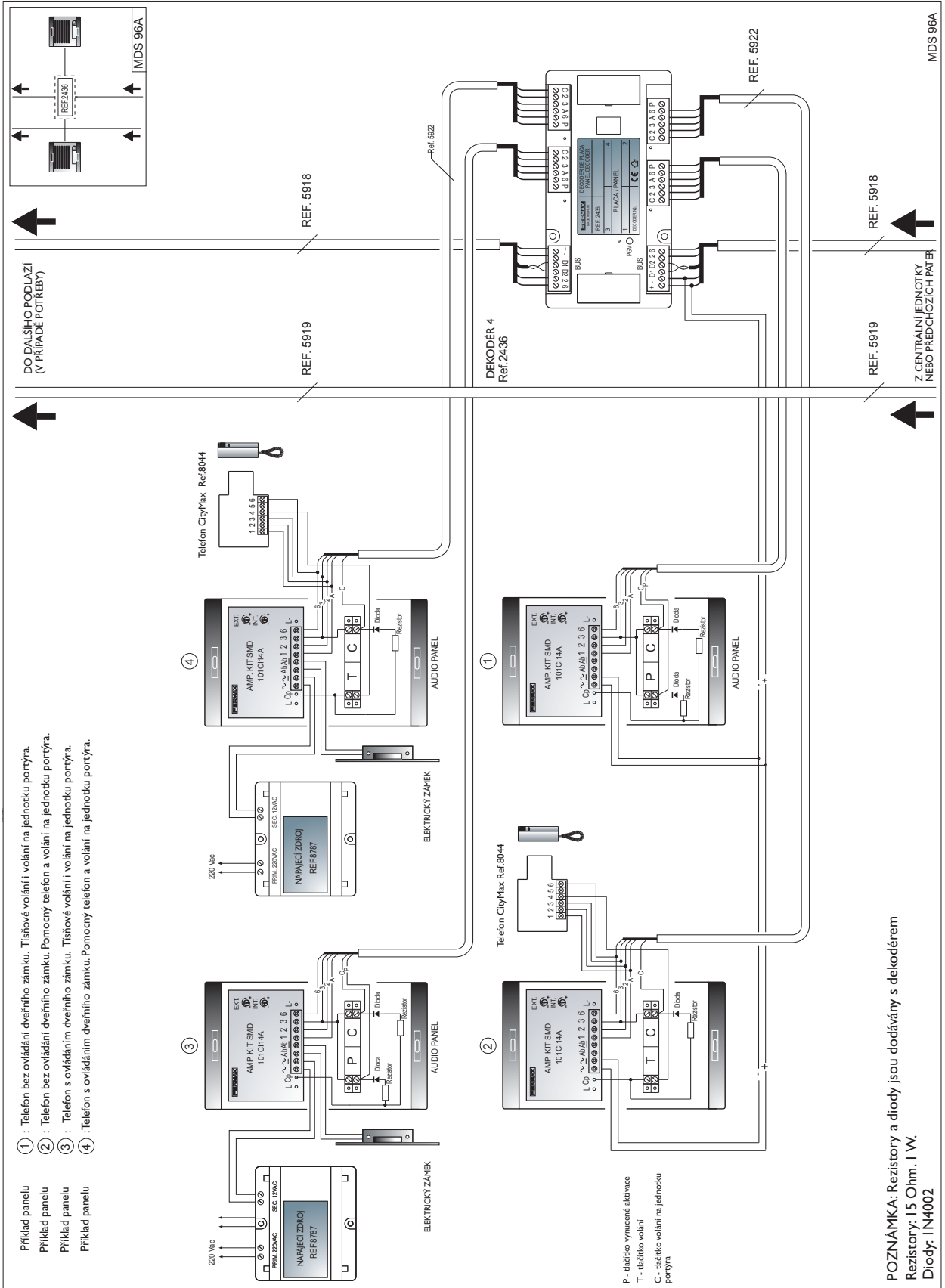

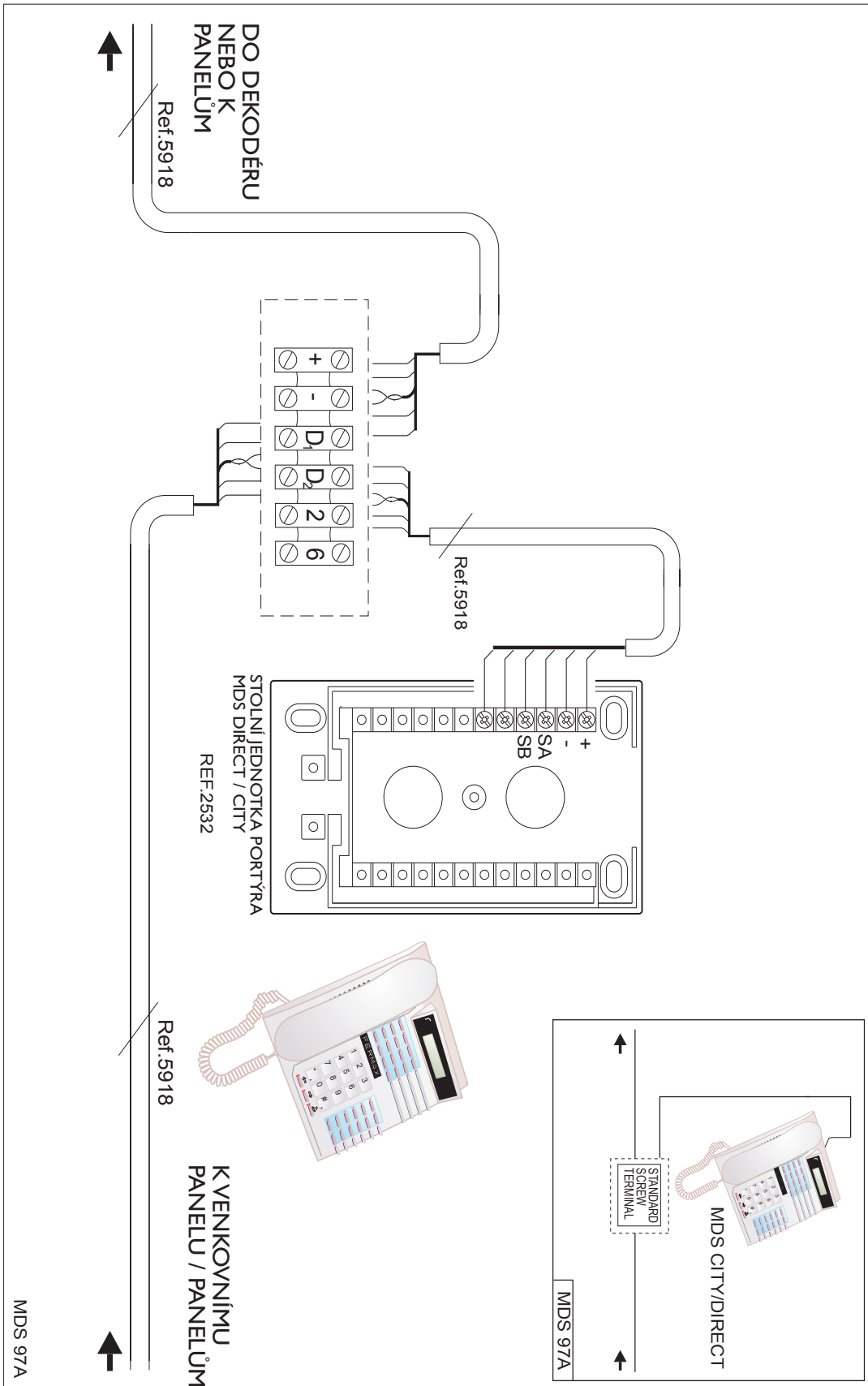

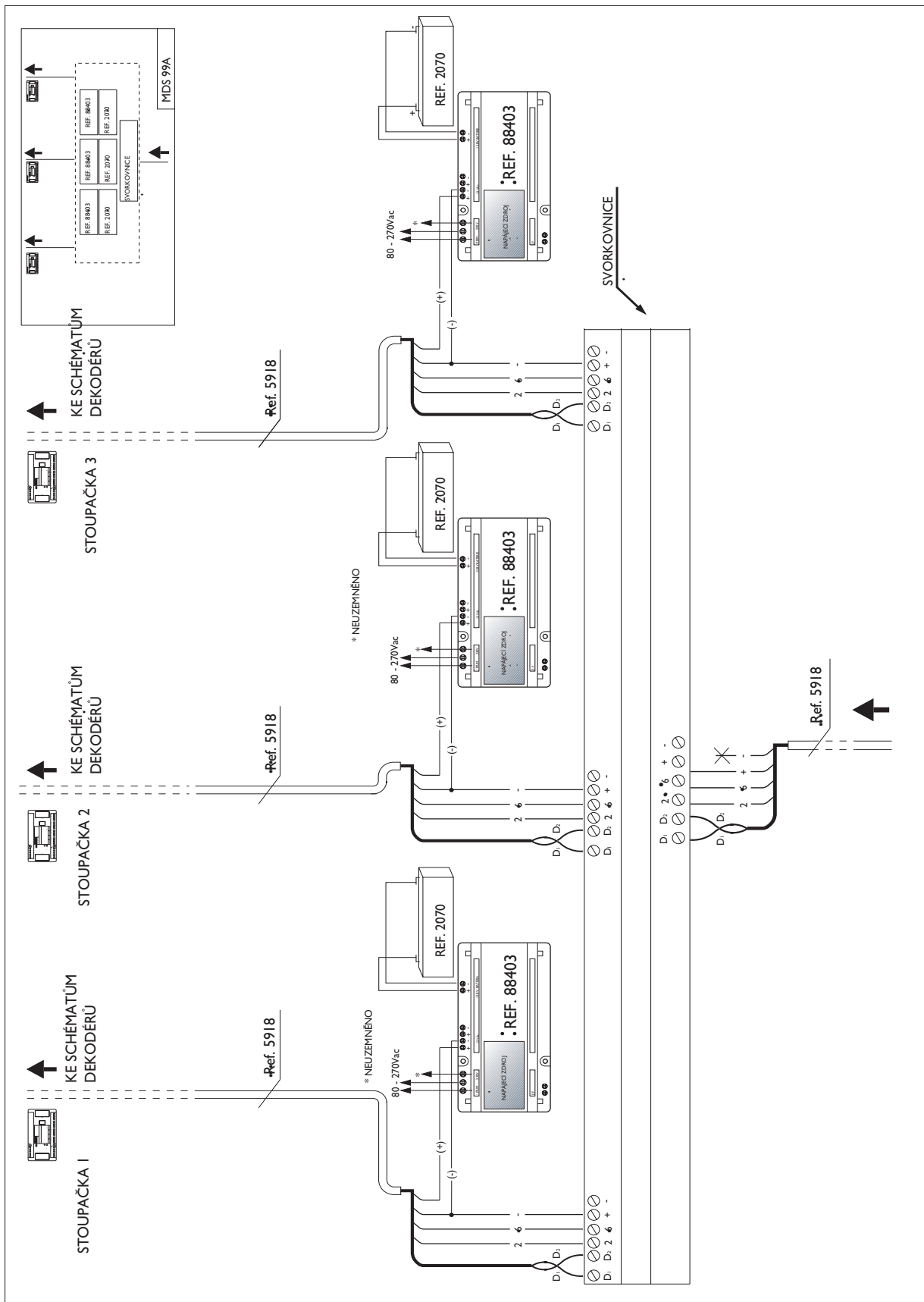

MDS 103U

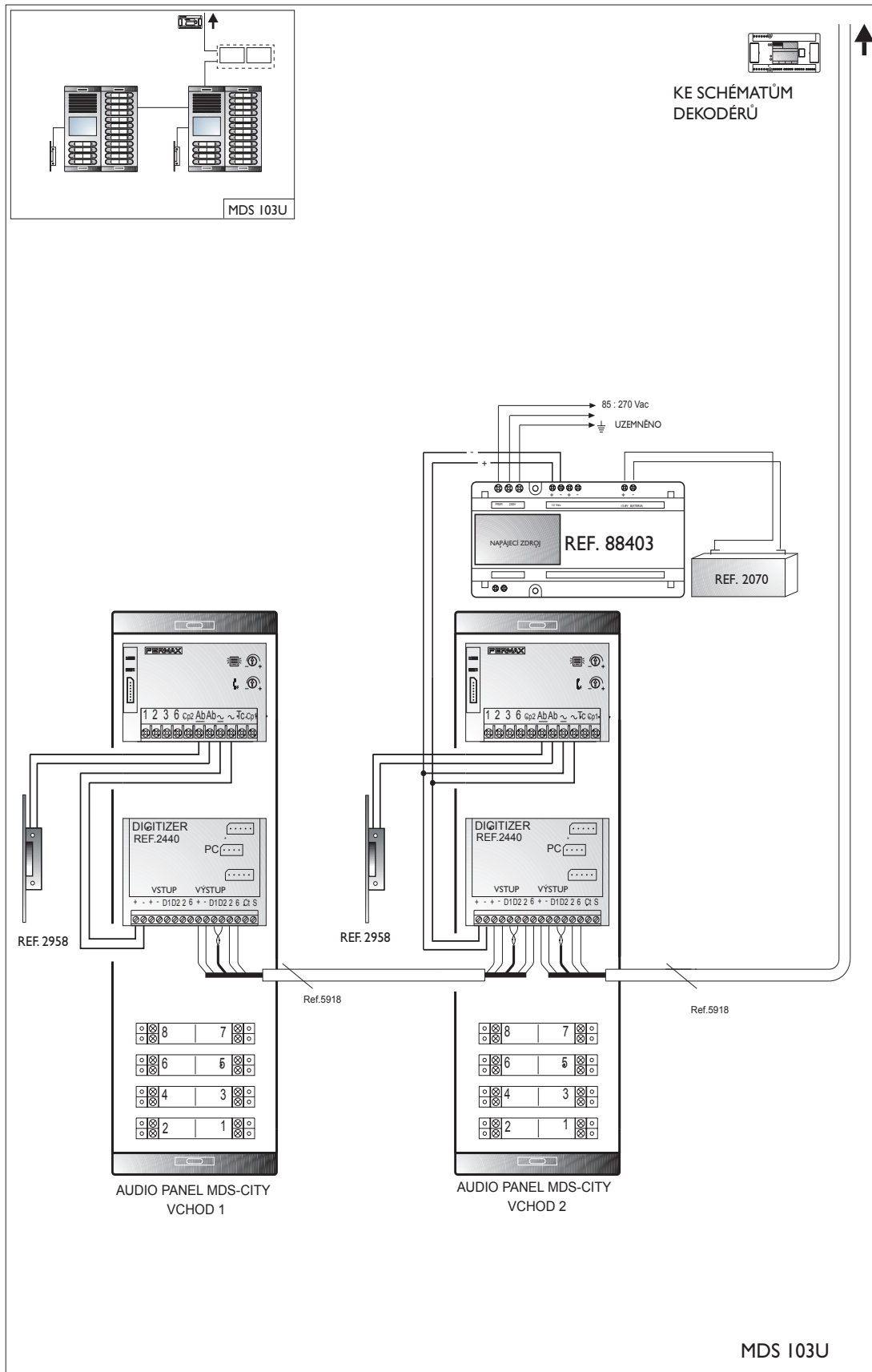

MDS 116U

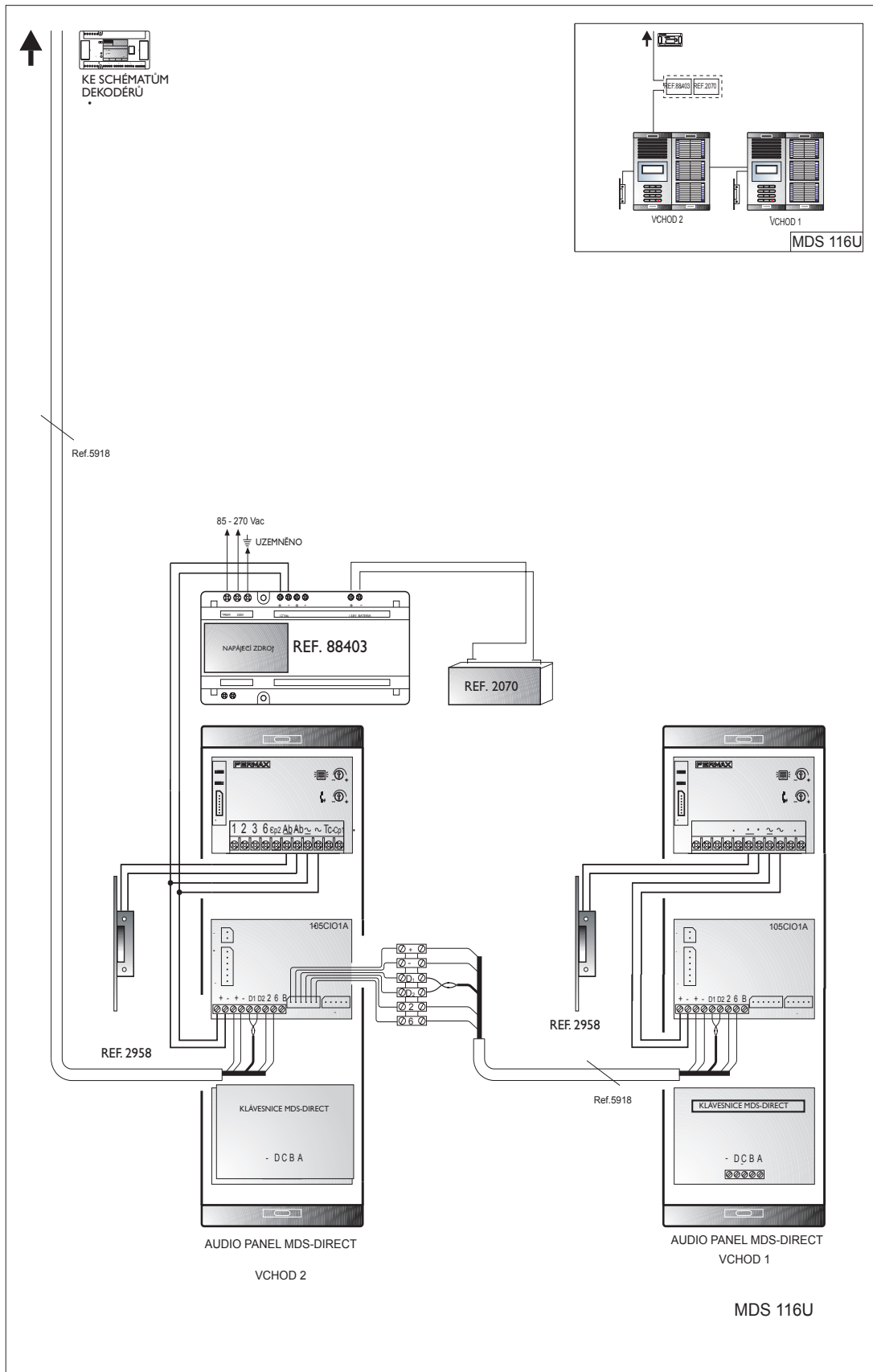

MDS 117U

